



CATÁLOGO GENERAL





Cada tirador es una oportunidad para crear algo único,
innovador e inspirador.

*Each handle is an opportunity to create something unique,
innovative & inspiring.*

SC nace en 1995 especializada en el diseño de complementos
para la industria del mueble y el conocimiento de su mercado.

Nuestro objetivo es conseguir que cada pieza otorgue un valor
especial a los entornos más cotidianos, que se mezcle con el
espacio para crear un significado personal en cada hogar.

SC was founded in 1995, specializing in market knowledge and
design accessories for the furniture industry.

Our goal is to give each piece a special value to the everyday
environments, to blend with the space in order to create a personal
meaning in every home.



Francisco García



José Linares

El optimismo firme y paciente siempre rinde sus frutos.





Diseño, pasión, perfección.

Rubén García

En SC la creatividad y la innovación continua, son la clave para crear nuestra exclusiva colección de tiradores.

Design, passion, perfection.

Rubén García

In SC, the creativity and continuous innovation are the keys to creating our collection of exclusive handles.

Habla claro, te escuchamos.

José Antonio Pérez

En SC sabemos que la comunicación es el pilar básico de la confianza. Por ello, nuestra red comercial permite un entendimiento personalizado y directo para encontrar las soluciones que cumplan con tus expectativas.

Talk to Us, we listen.

José Antonio Pérez

En SC sabemos que la comunicación es el pilar básico de la confianza. Por ello, nuestra red comercial permite un entendimiento personalizado y directo para encontrar las soluciones que cumplan con tus expectativas.

Cuando la calidad es un hábito, el éxito es la consecuencia.

SC HERRAJES

Con el certificado de calidad AENOR desde 2004 y una amplia gama de diseños patentados queremos ofrecer la seguridad que necesitas para marcar la diferencia frente a la competitividad del mercado actual.



Where quality is a habit, success is the result.

SC HERRAJES

With the AENOR quality certificate since 2004 and a wide range of patented designs, we offer the security and confidence you need in front of the competitiveness of the nowadays market.



Conocemos los límites, para poder superarlos.

María Galgau

SC sirve diseños de alta calidad por todo el mundo con la convicción de ofrecer un servicio profesional incluso en los mercados más exigentes.

Know the limit, in order to overcome it.

María Galgau







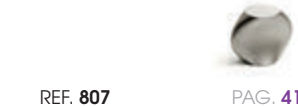
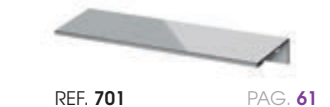









































SC serves top-quality designs all over the world with the conviction to offer a professional service even in the most demanding markets.



| ref. | pag. | ref. | pag. | ref. | pag. |
|------|------|------|------|-----------|------|
| 21 | 117 | 380 | 39 | 803 | 38 |
| 22 | 116 | 380H | 39 | 804 | 36 |
| 25 | 115 | 381 | 67 | 805 | 37 |
| 26 | 116 | 382 | 71 | 806 | 38 |
| 240 | 54 | 383 | 67 | 807 | 41 |
| 240R | 109 | 385 | 66 | 808 | 70 |
| 241 | 54 | 389 | 65 | 809 | 35 |
| 241R | 109 | 396 | 63 | 810 | 85 |
| 244 | 52 | 397 | 62 | 811 | 84 |
| 281 | 53 | 399 | 64 | 812 | 83 |
| 283 | 107 | 400 | 64 | 813 | 34 |
| 285 | 53 | 520 | 55 | 814 | 33 |
| 293 | 107 | 521 | 55 | 815 | 32 |
| 296 | 107 | 532 | 71 | 816 | 30 |
| 305 | 51 | 535 | 69 | 817 | 29 |
| 321 | 52 | 542 | 110 | 818 | 26 |
| 322 | 52 | 543 | 110 | 819 | 82 |
| 327 | 72 | 554 | 108 | 820 | 81 |
| 334 | 108 | 555 | 108 | 821 | 114 |
| 335 | 108 | 556 | 111 | 822 | 114 |
| 342 | 108 | 557 | 111 | 823 | 24 |
| 345 | 106 | 576 | 41 | 824 | 22 |
| 346 | 106 | 582 | 86 | 825 | 20 |
| 347 | 105 | 701 | 61 | 826 | 80 |
| 348 | 104 | 702 | 61 | 827 | 79 |
| 349 | 104 | 703 | 60 | 828 | 19 |
| 351 | 91 | 704 | 60 | 829 | 18 |
| 352 | 91 | 706 | 57 | 830 | 17 |
| 353 | 87 | 707 | 57 | 831 | 78 |
| 355 | 91 | 708 | 57 | 832 | 16 |
| 365 | 50 | 709 | 58 | 834 | 14 |
| 366 | 49 | 750 | 97 | 835 | 13 |
| 367 | 49 | 751 | 98 | 836 | 12 |
| 368 | 48 | 752 | 99 | 837 | 11 |
| 368R | 109 | 753 | 100 | 838 | 10 |
| 369 | 47 | 754 | 100 | 839 | 9 |
| 370 | 46 | 755 | 101 | 840 | 77 |
| 371 | 47 | 756 | 101 | 841 | 76 |
| 372 | 47 | 760 | 94 | 842 | 8 |
| 373 | 45 | 761 | 92 | L105 | 118 |
| 374 | 44 | 762 | 92 | L106 | 119 |
| 375 | 44 | 765 | 90 | L107 | 119 |
| 376 | 44 | 766 | 88 | L108 | 120 |
| 377 | 42 | 767 | 88 | FOCOS LED | 121 |
| 378 | 40 | 801 | 36 | ACC. LED | 122 |
| 379 | 87 | 802 | 37 | T. VIDRIO | 123 |



Indice por colección / index by collection

| | | | |
|--|--|---|---|
|  REF. 385 PAG. 66 |  REF. 372 PAG. 47 |  REF. 285 PAG. 53 |  REF. 819 PAG. 82 |
|  REF. 383 PAG. 67 |  REF. 371 PAG. 47 |  REF. 281 PAG. 53 |  REF. 812 PAG. 83 |
|  REF. 382 PAG. 71 |  REF. 370 PAG. 46 |  REF. 244 PAG. 52 |  REF. 811 PAG. 84 |
|  REF. 381 PAG. 67 |  REF. 369 PAG. 47 |  REF. 241 PAG. 54 |  REF. 810 PAG. 85 |
|  REF. 380H PAG. 39 |  REF. 368 PAG. 48 |  REF. 240 PAG. 54 |  REF. 767 PAG. 88 |
|  REF. 380 PAG. 39 |  REF. 367 PAG. 49 |  FUSION |  REF. 766 PAG. 88 |
|  REF. 378 PAG. 40 |  REF. 366 PAG. 49 |  REF. 841 PAG. 76 |  REF. 765 PAG. 90 |
|  REF. 377 PAG. 42 |  REF. 365 PAG. 50 |  REF. 840 PAG. 77 |  REF. 762 PAG. 92 |
|  REF. 376 PAG. 44 |  REF. 327 PAG. 72 |  REF. 831 PAG. 78 |  REF. 761 PAG. 95 |
|  REF. 375 PAG. 44 |  REF. 322 PAG. 52 |  REF. 827 PAG. 79 |  REF. 760 PAG. 96 |
|  REF. 374 PAG. 44 |  REF. 321 PAG. 52 |  REF. 826 PAG. 80 |  REF. 756 PAG. 101 |
|  REF. 373 PAG. 45 |  REF. 305 PAG. 51 |  REF. 820 PAG. 81 |  REF. 755 PAG. 101 |

| | | | |
|---|--|--|---|
|  REF. 754 PAG. 102 |  CLASSICS |  REF. 342 PAG. 110 |  REF. L105 PAG. 118 |
|  REF. 753 PAG. 102 |  REF. 557 PAG. 115 |  REF. 334 PAG. 110 |  REF. L106 PAG. 119 |
|  REF. 752 PAG. 101 |  REF. 556 PAG. 115 |  REF. 296 PAG. 109 |  REF. L107 PAG. 119 |
|  REF. 751 PAG. 100 |  REF. 555 PAG. 108 |  REF. 293 PAG. 109 |  REF. L108 PAG. 120 |
|  REF. 750 PAG. 99 |  REF. 554 PAG. 108 |  REF. 283 PAG. 109 |  REF. L160.80 PAG. 121 |
|  REF. 582 PAG. 86 |  REF. 543 PAG. 112 |  ACCESORIOS |  REF. L160.60 PAG. 121 |
|  REF. 379 PAG. 87 |  REF. 542 PAG. 112 |  REF. 822 PAG. 114 |  REF. L160.65 PAG. 121 |
|  REF. 355 PAG. 91 |  REF. 368R PAG. 111 |  REF. 821 PAG. 114 |  REF. L160.62 PAG. 121 |
|  REF. 353 PAG. 87 |  REF. 349 PAG. 106 |  REF. 26 PAG. 116 |  REF. L141.72 PAG. 122 |
|  REF. 352 PAG. 91 |  REF. 348 PAG. 106 |  REF. 25 PAG. 115 |  REF. L140.72 PAG. 122 |
|  REF. 351 PAG. 91 |  REF. 347 PAG. 107 |  REF. 22 PAG. 116 |  REF. L131 PAG. 122 |
|  REF. 346 PAG. 108 |  REF. 345 PAG. 108 |  REF. 21 PAG. 117 |  TIRAS LED PAG. 122 |



ESSENTIALS 6



FUSION 74

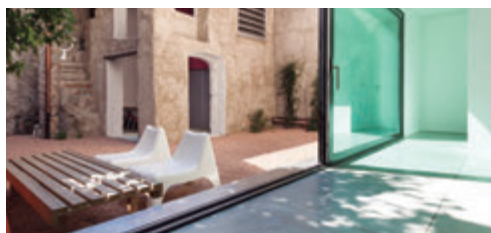

CLASSICS 104



ACCESORIOS 112





**LA MEJOR OPCIÓN
ES LA QUE MARCA LA DIFERENCIA**

Nuestros Essentials ofrecen un toque de originalidad y modernidad con diseños que saben adaptarse a cualquier entorno.

Las formas expresivas y la combinación de materiales crean atractivos contrastes y otorgan un carácter único y atrevido a cada modelo.

ESSENTIALS

**THE BEST OPTION
IS THE ONE THAT MAKES THE DIFFERENCE**

Our Essentials offer a touch of originality and modernity with designs that adapt to any environment.





The expressive forms and combination of materials create attractive contrasts and give them a unique and daring character to each model.

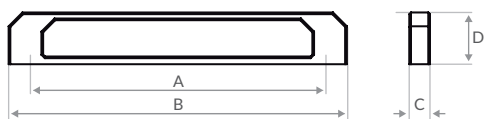

design by D.Lava





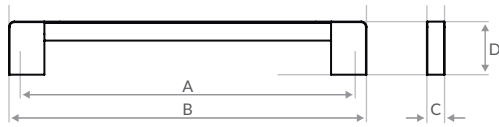

842

| zamak | Acabado finishes | Ref. model | A | B | C | D |  |  |
|---|--|------------|-----|-----|----|----|---|---|
|  | Cromo Brillo <i>bright chrome</i> | 842.160.04 | 160 | 196 | 12 | 30 | 25 | 75 |
|  | Níquel Satinado <i>brush satin nickel</i> | 842.160.58 | 160 | 196 | 12 | 30 | 25 | 75 |



839

| zamak | Acabado finishes | Ref. model | A | B | C | D |  |  |
|---|---|---------------|-----|-----|----|----|---|---|
|  | Níquel Satinado / Cromo brillo <i>brush satin nickel / bright chrome</i> | 839.192.58-04 | 192 | 202 | 12 | 30 | 25 | 75 |
|  | Cromo Brillo / Negro <i>bright chrome / black</i> | 839.192.04-08 | 192 | 202 | 12 | 30 | 25 | 75 |
|  | Níquel Satinado / Negro <i>brush satin nickel / black</i> | 839.192.58-08 | 192 | 202 | 12 | 30 | 25 | 75 |

design by D.Cava

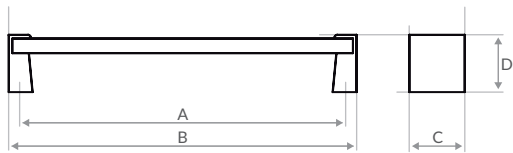



838

aluminio/zamak Acabado finishes



Níquel Satinado / Cromo Brillo
brush satin nickel / bright chrome

| Ref. model | A | B | C | D |  |  |
|---------------|---|-----|----|----|---|---|
| 838.160.58-04 | 160 | 173 | 30 | 31 | 25 | 75 |
| 838.192.58-04 | 192 | 205 | 30 | 31 | 25 | 75 |
| 838.292.58-04 | 292 | 305 | 30 | 31 | 25 | 75 |
| 838.392.58-04 | 392 | 405 | 30 | 31 | 15 | 45 |
| 838.492.58-04 | 492 | 505 | 30 | 31 | 15 | 45 |
| 838.692.58-04 | 692 | 705 | 30 | 31 | 15 | 45 |
| 838. 030.04 | Pata Zamak / Zinc foot | | | | | 50 |
| 838.2000.58 | Perfil Aluminio 2m / 2m Aluminium profile | | | | | 10 |



837

zamak

Acabado finishes

Ref. model

A

B

C

D



Cromo Brillo / Negro
bright chrome / black

837.192.04-08

192

202

18

32

25

75



Níquel Satinado / Negro
brush satin nickel / black

837.192.58-08

192

202

18

32

25

75



Níquel Satinado / Blanco
brush satin nickel / white

837.192.58-06

192

202

18

32

25



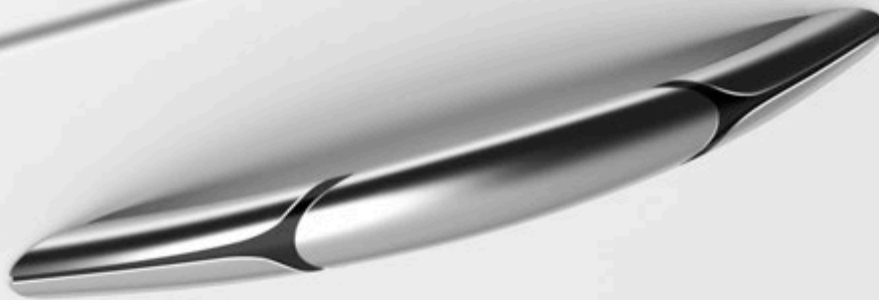

75

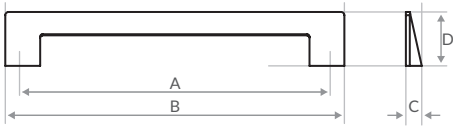
design by D.Lava





836

| zamak | Acabado finishes | Ref. model | A | B | C | D |  |  |
|---|--|------------|-----|-----|----|----|---|---|
|  | Cromo Brillo <i>bright chrome</i> | 836.192.04 | 192 | 214 | 10 | 35 | 25 | 75 |
| | | 836.320.04 | 320 | 342 | 10 | 35 | 25 | 75 |
|  | Níquel Satinado <i>brush satin nickel</i> | 836.192.58 | 192 | 214 | 10 | 35 | 25 | 75 |
| | | 836.320.58 | 320 | 342 | 10 | 35 | 25 | 75 |

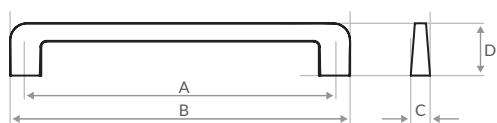

835

zamac

Acabado finishes

Ref. model

A

B

C

D



Cromo Brillo
bright chrome

835.192.04
835.256.04

192
256

211
275

12
12

33
33

25
25

75
75



Níquel Satinado
brush satin nickel

835.192.58
835.256.58

192
256

211
275

12
12

33
33



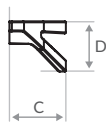
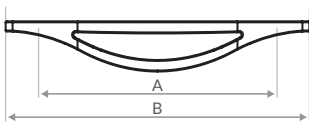

25
25

75
75





834



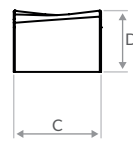
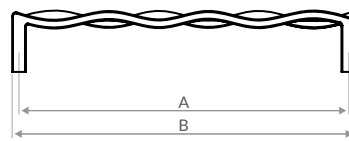
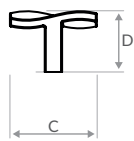
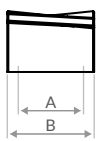
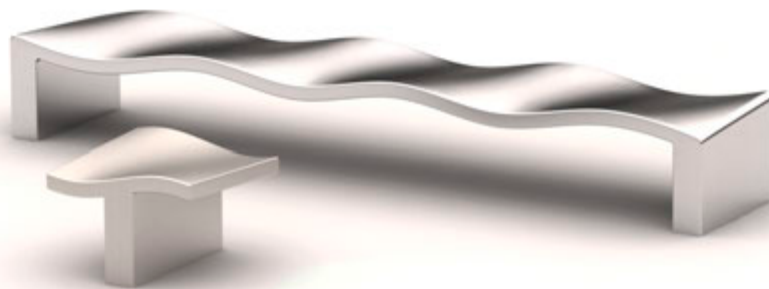

| zamak | Acabado finishes | Ref. model | A | B | C | D |  |  |
|---|--|------------|-----|-----|----|----|---|---|
|  | Cromo Brillo <i>bright chrome</i> | 834.096.04 | 96 | 150 | 25 | 20 | 25 | 75 |
| | | 834.160.04 | 160 | 250 | 28 | 25 | 25 | 75 |
| | | 834.256.04 | 256 | 400 | 32 | 30 | 25 | 75 |
|  | Níquel Satinado <i>brush satin nickel</i> | 834.096.58 | 96 | 150 | 25 | 20 | 25 | 75 |
| | | 834.160.58 | 160 | 250 | 28 | 25 | 25 | 75 |
| | | 834.256.58 | 256 | 400 | 32 | 30 | 25 | 75 |

Encuentra tu ESTILO
find your style





832

| zamak | Acabado finishes | Ref. model | A | B | C | D |  |  |
|---|--|------------|-----|-----|----|----|---|---|
|  | Cromo Brillo <i>bright chrome</i> | 832.032.04 | 32 | 40 | 40 | 28 | 25 | 100 |
| | | 832.192.04 | 192 | 200 | 40 | 28 | 25 | 75 |
|  | Níquel Satinado <i>brush satin nickel</i> | 832.032.58 | 32 | 40 | 40 | 28 | 25 | 100 |
| | | 832.192.58 | 192 | 200 | 40 | 28 | 25 | 75 |

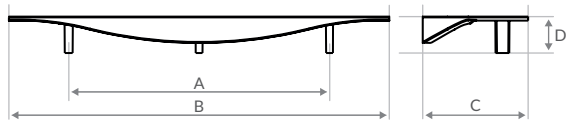

830

zamak

Acabado finishes

Ref. model

A

B

C

D



Cromo Brillo
bright chrome

830.146.04

96

146

39

10

25

100

830.280.04

192

280

39

10

25

75

830.446.04

384

446

39

10

25

75



Níquel Satinado
brush satin nickel

830.146.58

96

146

39

10

25

100

830.280.58

192

280

39

10

25

75

830.446.58

384

446

39

10



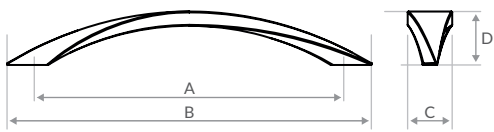
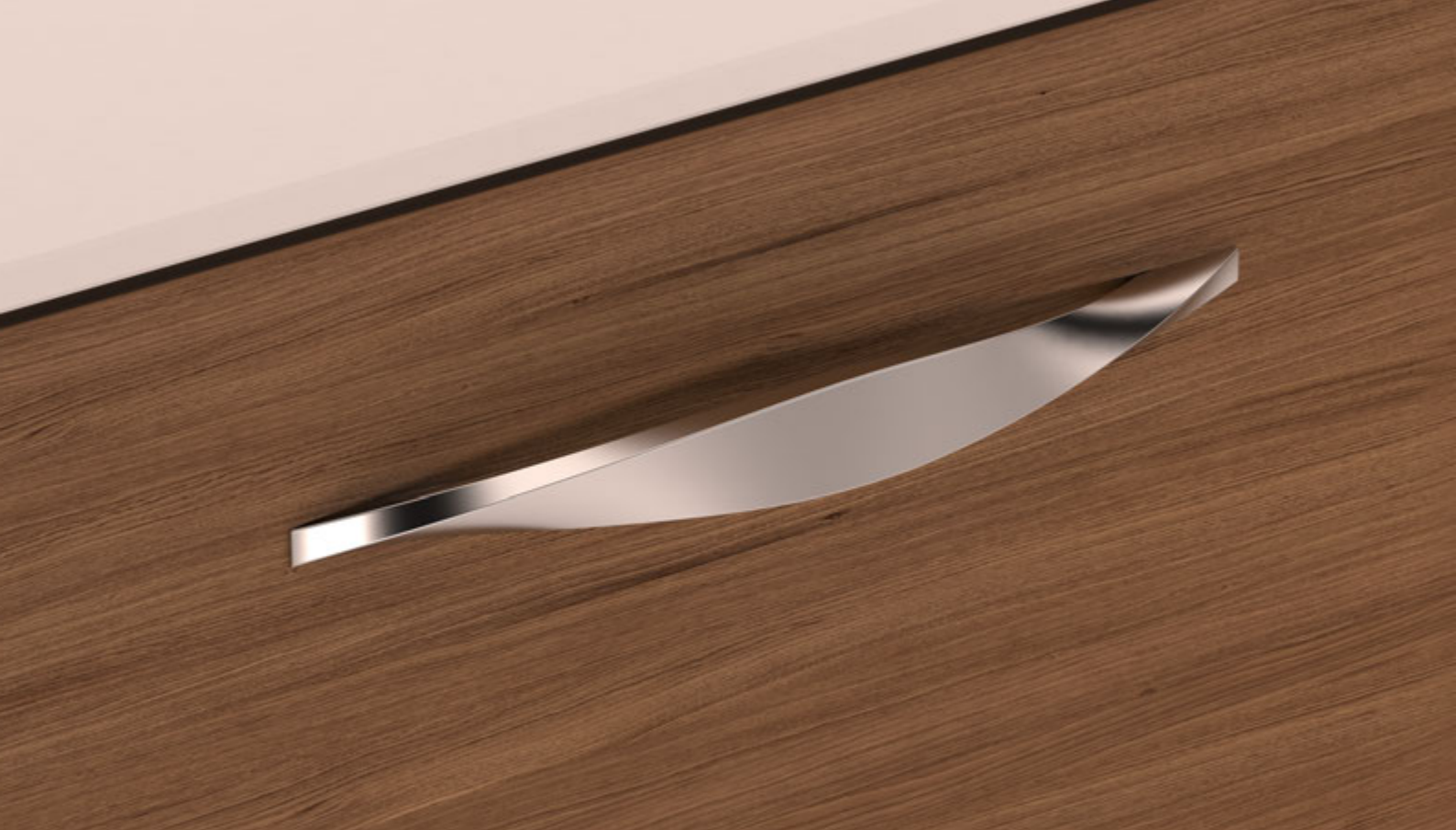

25

75





829

| zamak | Acabado finishes | Ref. model | A | B | C | D |  |  |
|---|--|------------|-----|-----|----|----|---|---|
|  | Cromo Brillo <i>bright chrome</i> | 829.192.04 | 192 | 237 | 25 | 30 | 25 | 75 |
|  | Níquel Satinado <i>brush satin nickel</i> | 829.192.58 | 192 | 237 | 25 | 30 | 25 | 75 |

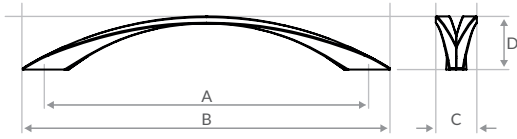

828

zamak

Acabado finishes

Ref. model

A

B

C

D



Níquel Satinado / Cromo Brillo
brush satin nickel / bright chrome

828.192.58-04

192

232

26

34

25

100



Cromo Brillo / Negro
bright chrome / black

828.192.04-08

192

232

26

34

25

100



Níquel Satinado / Negro
brush satin nickel / black

828.192.58-08

192

232

26

34



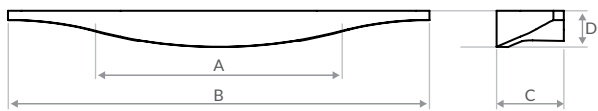

25

100





825



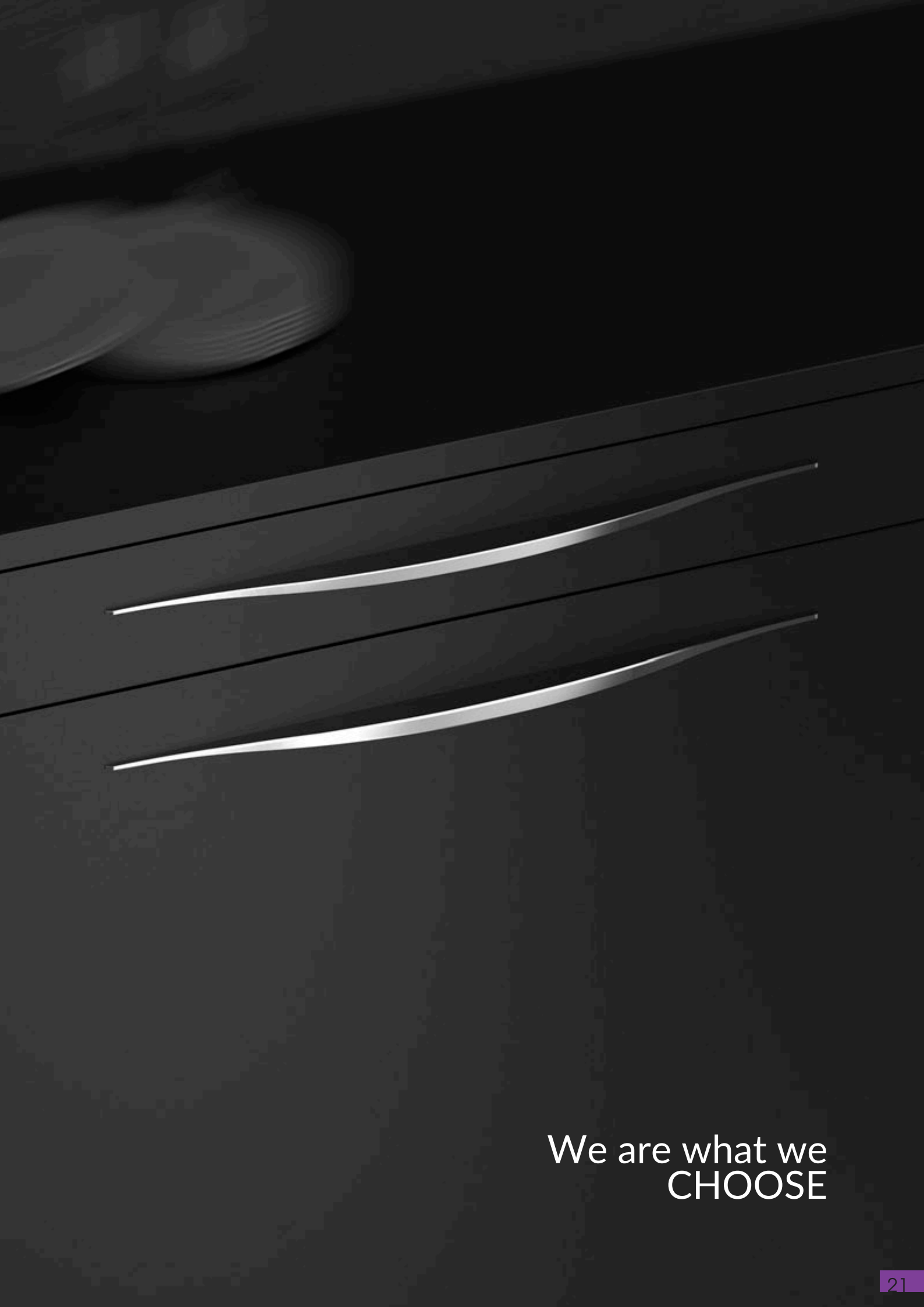

| zamak | Acabado finishes | Ref. model | A | B | C | D |  |  |
|---|--|------------|-----|-----|----|----|---|---|
|  | Cromo Brillo <i>bright chrome</i> | 825.064.04 | 64 | 145 | 18 | 10 | 25 | 100 |
| | | 825.160.04 | 160 | 280 | 20 | 10 | 25 | 75 |
| | | 825.256.04 | 256 | 446 | 20 | 11 | 25 | 75 |
|  | Níquel Satinado <i>brush satin nickel</i> | 825.064.58 | 64 | 145 | 18 | 10 | 25 | 100 |
| | | 825.160.58 | 160 | 280 | 20 | 10 | 25 | 75 |
| | | 825.256.58 | 256 | 446 | 20 | 11 | 25 | 75 |

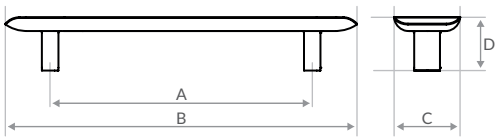
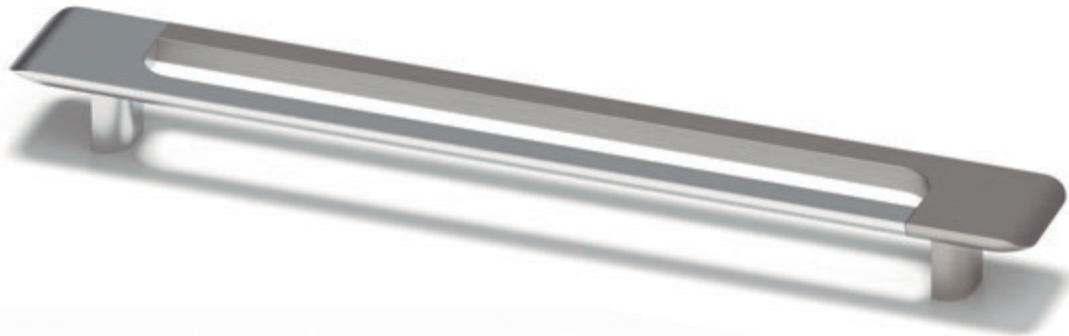

We are what we
CHOOSE



824

| zamak | Acabado finishes | Ref. model | A | B | C | D |  |  |
|---|---|---------------|-----|-----|----|----|---|---|
|  | Níquel Satinado / Cromo Brillo <i>brush satin nickel / bright chrome</i> | 824.160.58-04 | 160 | 208 | 36 | 29 | 25 | 100 |
| | | 824.224.58-04 | 224 | 272 | 36 | 29 | 25 | 100 |
|  | Negro / Cromo Brillo <i>black / bright chrome</i> | 824.160.08-04 | 160 | 208 | 36 | 29 | 25 | 100 |
| | | 824.224.08-04 | 224 | 272 | 36 | 29 | 25 | 100 |
|  | Níquel Satinado / Negro <i>brush satin nickel / black</i> | 824.160.58-08 | 160 | 208 | 36 | 29 | 25 | 100 |
| | | 824.224.58-08 | 224 | 272 | 36 | 29 | 25 | 100 |



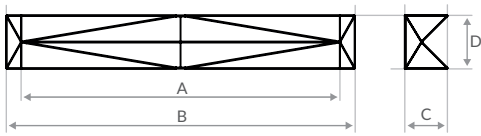
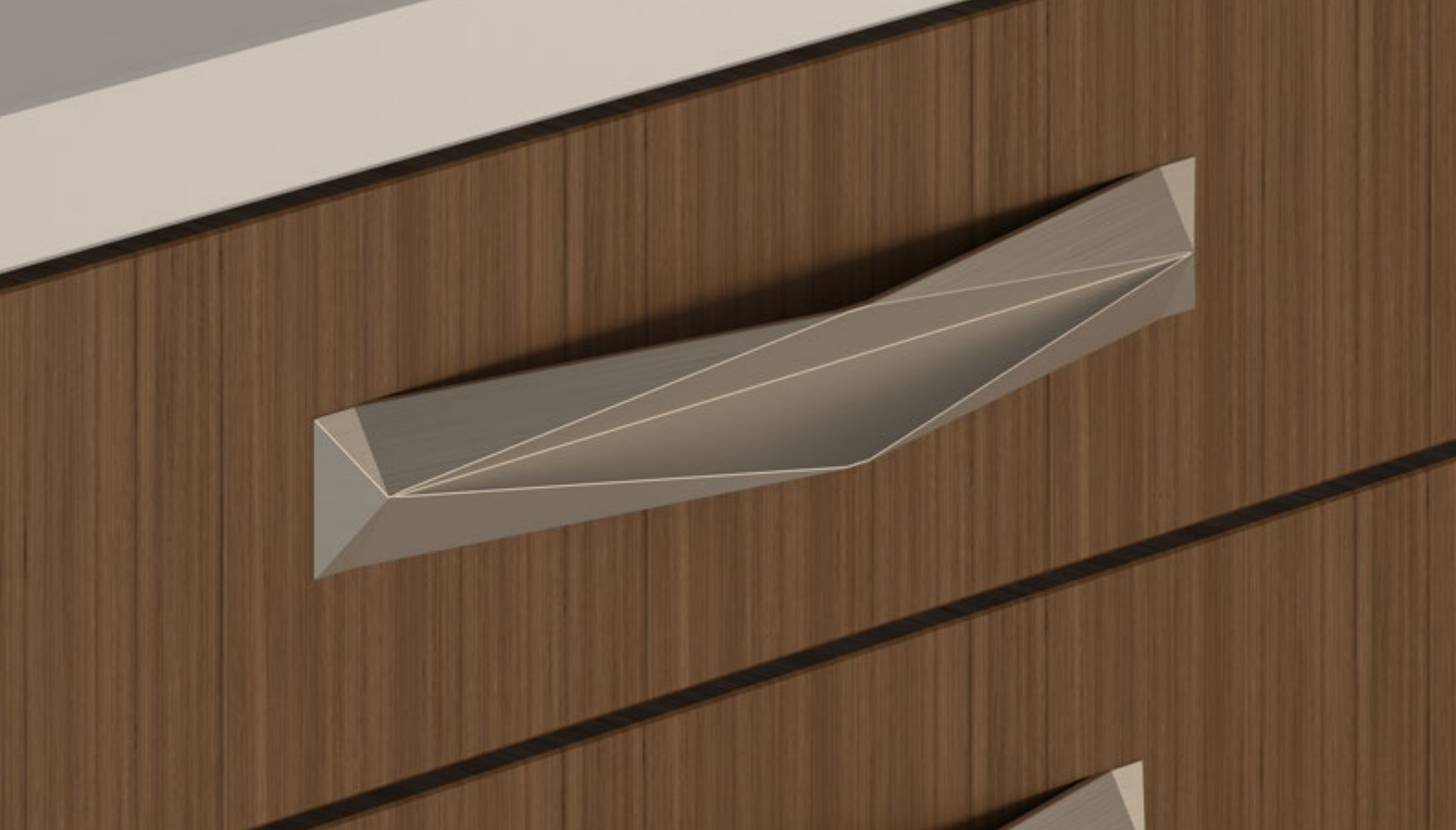

823

zamak

Acabado finishes

Ref. model

A

B

C

D



Níquel Satinado
brush satin nickel

823.256.58

256

284

40

32

20

80



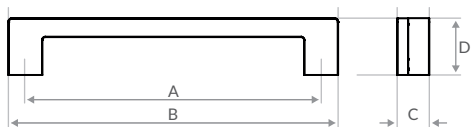

A man with short dark hair and a light beard, wearing a blue button-down shirt, is positioned in the lower right corner of the frame. He is looking directly at the camera with a neutral expression. The background is a dramatic, low-angle shot of a modern architectural interior. The ceiling is a deep, solid blue, while the walls and large curved structures are white with a grid-like pattern of recessed lines. The lighting is soft and directional, highlighting the textures and curves of the architecture.

DAVID CAVA

El joven diseñador valenciano se une al equipo de SC en la creación de nuevos modelos.



818

| zamak | Acabado finishes | Ref. model | A | B | C | D |  |  |
|---|---|---------------|-----|-----|----|----|---|---|
|  | Níquel Satinado / Cromo Brillo <i>brush satin nickel / bright chrome</i> | 818.128.58-04 | 128 | 146 | 16 | 30 | 25 | 75 |
| | | 818.192.58-04 | 192 | 210 | 16 | 30 | 25 | 75 |
| | | 818.320.58-04 | 320 | 338 | 16 | 30 | 25 | 75 |
|  | Negro / Cromo Brillo <i>black / bright chrome</i> | 818.128.08-04 | 128 | 146 | 16 | 30 | 25 | 75 |
| | | 818.192.08-04 | 192 | 210 | 16 | 30 | 25 | 75 |
| | | 818.320.08-04 | 320 | 338 | 16 | 30 | 25 | 75 |
|  | Níquel Satinado / Negro <i>brush satin nickel / black</i> | 818.128.58-08 | 128 | 146 | 16 | 30 | 25 | 75 |
| | | 818.192.58-08 | 192 | 210 | 16 | 30 | 25 | 75 |
| | | 818.320.58-08 | 320 | 338 | 16 | 30 | 25 | 75 |



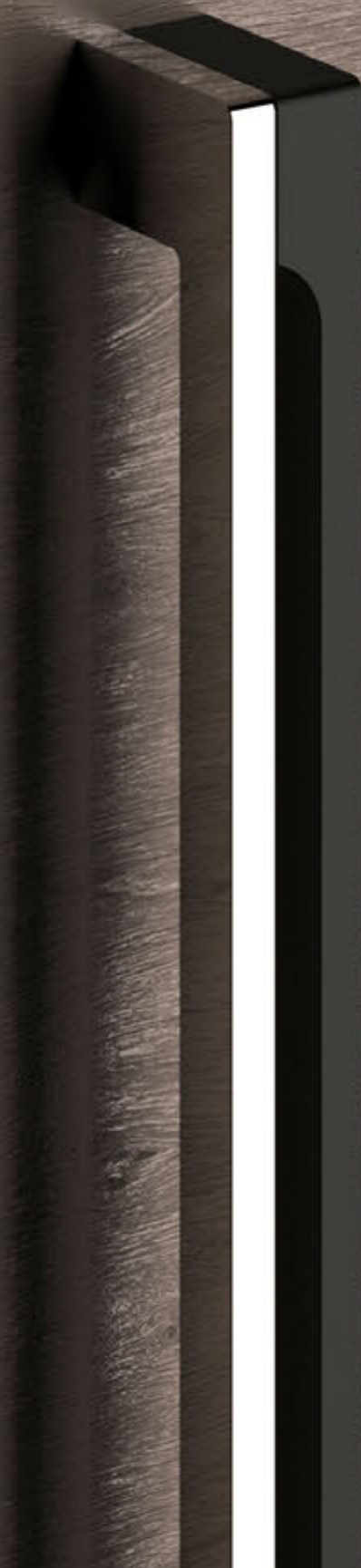

CREATIVITY
IS THE KEY

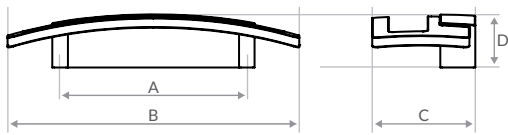









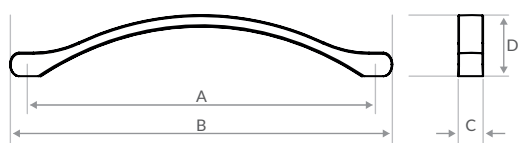

817

| zamak | Acabado finishes | Ref. model | A | B | C | D |  |  |
|---|--|------------|--|-----|----|----|---|---|
|  | Cromo Brillo <i>bright chrome</i> | 817.096.04 | 96 | 150 | 53 | 27 | 25 | 100 |
| | | 817.224.04 | 224 | 400 | 53 | 29 | 10 | 30 |
|  | Níquel Satinado <i>brush satin nickel</i> | 817.096.58 | 96 | 150 | 53 | 27 | 25 | 100 |
| | | 817.224.58 | 224 | 400 | 53 | 29 | 10 | 30 |
| | Opción LED <i>LED option</i> | 743.100.06 | sólo para modelo de 224mm <i>only for 224mm model</i> | | | | 40 | - |





816





| zamak | Acabado finishes | Ref. model | A | B | C | D |  |  |
|---|--|-------------|-----|-----|----|----|---|---|
|  | Cromo Brillo <i>bright chrome</i> | 816.128.04 | 128 | 136 | 10 | 26 | 25 | 75 |
| | | 816.192.04 | 192 | 200 | 10 | 26 | 25 | 75 |
| | | 816.256.04 | 256 | 264 | 10 | 26 | 25 | 75 |
|  | Cromo Mate <i>mat chrome</i> | 816.192.30 | 192 | 200 | 10 | 26 | 25 | 75 |
| | | 816.256.30 | 256 | 264 | 10 | 26 | 25 | 75 |
|  | Níquel Satinado <i>brush satin nickel</i> | 816.128.58 | 128 | 136 | 10 | 26 | 25 | 75 |
| | | 816.192.58 | 192 | 200 | 10 | 26 | 25 | 75 |
| | | 816.256.58 | 256 | 264 | 10 | 26 | 25 | 75 |
|  | Cromo Brillo / Swarovski <i>bright chrome / swarovski</i> | 816.192.04w | 192 | 200 | 10 | 26 | 25 | 75 |
| | | 816.256.04w | 256 | 264 | 10 | 26 | 25 | 75 |

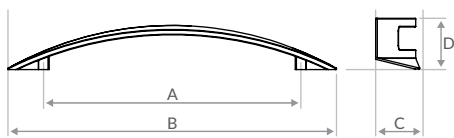
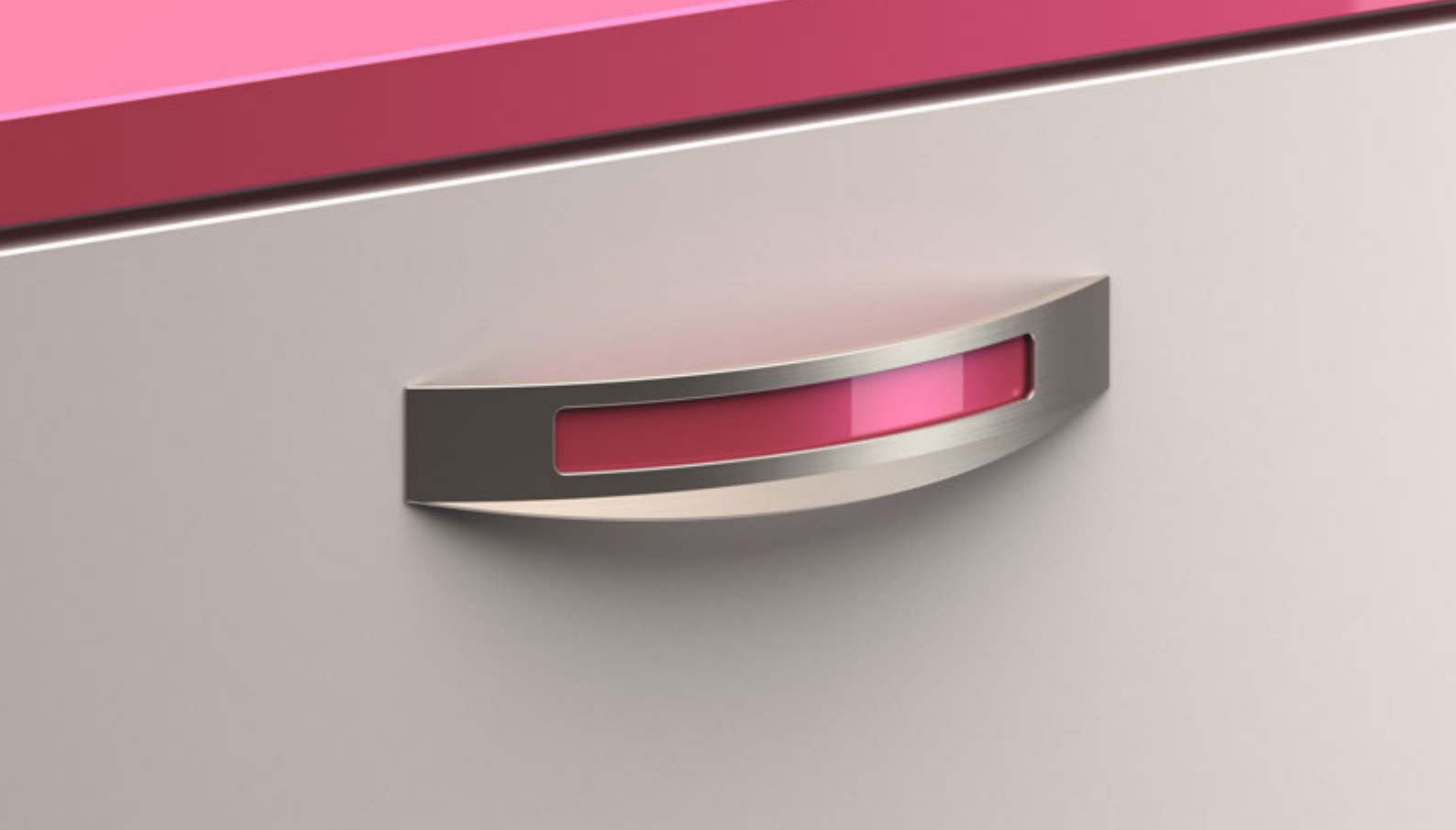

La elegancia comienza en
LA SENCILLEZ



815

| zamak | Acabado finishes | Ref. model | A | B | C | D |  |  |
|---|--|------------|-----|-----|----|----|---|---|
|  | Cromo Brillo <i>bright chrome</i> | 815.128.04 | 128 | 162 | 27 | 38 | 25 | 75 |
| | | 815.192.04 | 192 | 256 | 32 | 38 | 25 | 75 |
|  | Cromo Mate <i>mat chrome</i> | 815.128.30 | 128 | 162 | 27 | 38 | 25 | 75 |
| | | 815.192.30 | 192 | 256 | 32 | 38 | 25 | 75 |
|  | Níquel Satinado <i>brush satin nickel</i> | 815.128.58 | 128 | 162 | 27 | 38 | 25 | 75 |
| | | 815.192.58 | 192 | 256 | 32 | 38 | 25 | 75 |

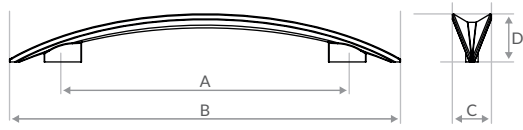

814

zamak

Acabado finishes

Ref. model

A

B

C

D



Cromo Brillo
bright chrome

814.160.04

160

220

22

27

25

75

814.192.04

192

260

27

31

25

75

814.320.04

320

400

36

38

25

75



Níquel Satinado
brush satin nickel

814.160.58

160

220

22

27

25

75

814.192.58

192

260

27

31

25

75

814.320.58

320

400

36

38



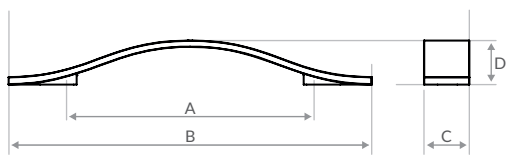
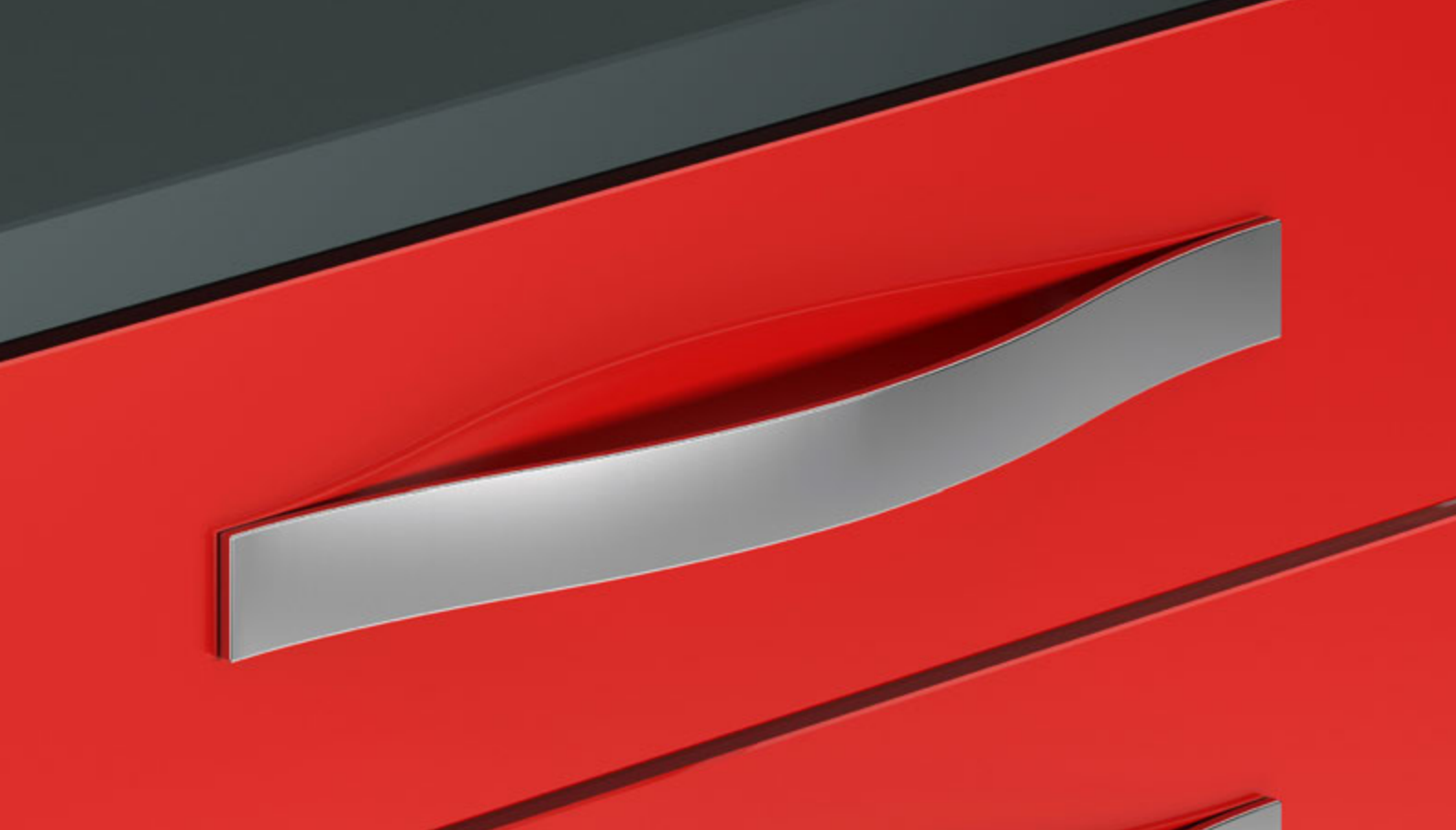

25

75







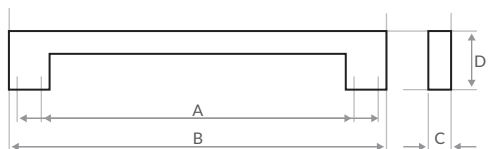
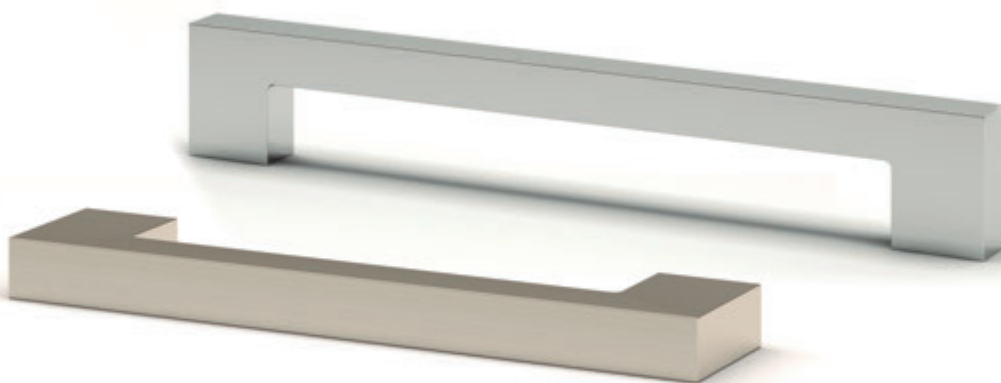

813

| zamak | Acabado finishes | Ref. model | A | B | C | D |  |  |
|---|--|------------|-----|-----|----|----|---|---|
|  | Cromo Brillo <i>bright chrome</i> | 813.096.04 | 96 | 170 | 25 | 18 | 25 | 75 |
| | | 813.160.04 | 160 | 240 | 30 | 29 | 25 | 75 |
| | | 813.256.04 | 256 | 380 | 32 | 36 | 12 | 36 |
|  | Cromo mate <i>mat chrome</i> | 813.096.30 | 96 | 170 | 25 | 18 | 25 | 75 |
| | | 813.160.30 | 160 | 240 | 30 | 29 | 25 | 75 |
| | | 813.256.30 | 256 | 380 | 32 | 36 | 12 | 36 |
|  | Níquel satinado <i>brush satin nickel</i> | 813.096.58 | 96 | 170 | 25 | 18 | 25 | 75 |
| | | 813.160.58 | 160 | 240 | 30 | 29 | 25 | 75 |
| | | 813.256.58 | 256 | 380 | 32 | 36 | 12 | 36 |



809



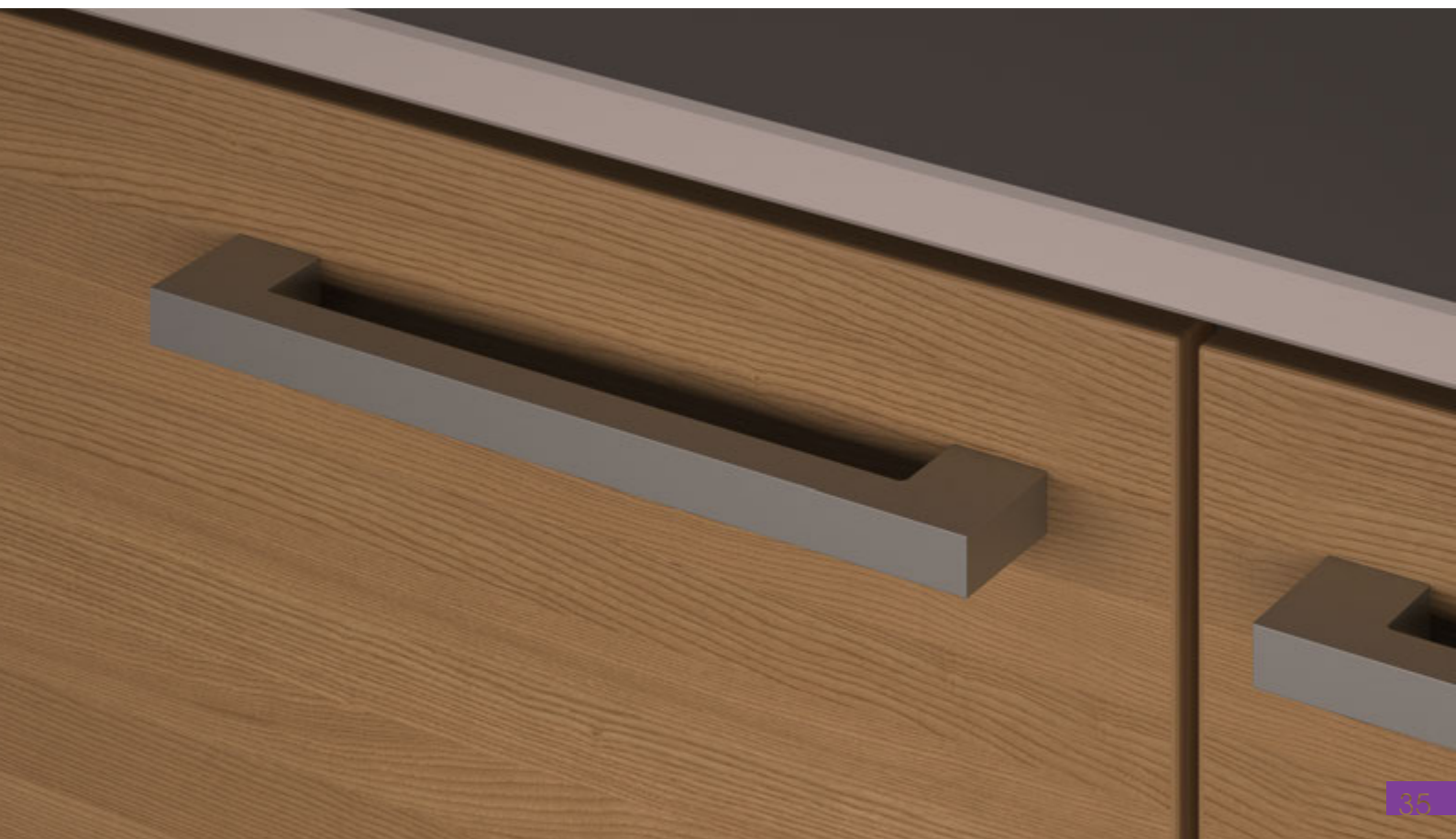

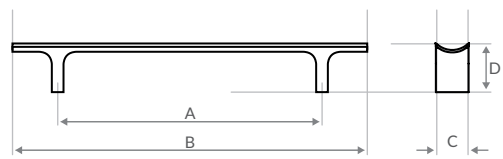
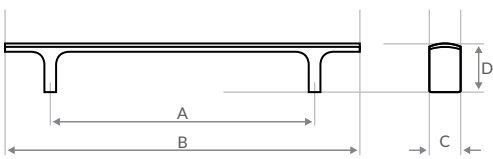
| zamak | Acabado finishes | Ref. model | A | B | C | D |  |  |
|---|--|------------|---------|-----|----|----|---|---|
|  | Cromo Brillo <i>bright chrome</i> | 809.160.04 | 128-160 | 168 | 14 | 36 | 25 | 75 |
| | | 809.224.04 | 192-224 | 232 | 14 | 36 | 15 | 45 |
|  | Cromo Mate <i>mat chrome</i> | 809.160.30 | 128-160 | 168 | 14 | 36 | 25 | 75 |
| | | 809.224.30 | 192-224 | 232 | 14 | 36 | 15 | 45 |
|  | Níquel Satinado <i>brush satin nickel</i> | 809.160.58 | 128-160 | 168 | 14 | 36 | 25 | 75 |
| | | 809.224.58 | 192-224 | 232 | 14 | 36 | 15 | 45 |





801

804

| zamak | Acabado finishes | Ref. model | A | B | C | D |  |  |
|---|---|------------|-----|-----|----|----|---|---|
|  | Cromo Brillo <i>bright chrome</i> | 801.192.04 | 192 | 256 | 16 | 29 | 25 | 75 |
| | | 804.192.04 | 192 | 256 | 16 | 29 | 25 | 75 |
|  | Cromo Mate <i>mat chrome</i> | 801.192.30 | 192 | 256 | 16 | 29 | 25 | 75 |
| | | 804.192.30 | 192 | 256 | 16 | 29 | 25 | 75 |
|  | Níquel Satinado <i>brush satin nickel</i> | 801.192.58 | 192 | 256 | 16 | 29 | 25 | 75 |
| | | 804.192.58 | 192 | 256 | 16 | 29 | 25 | 75 |

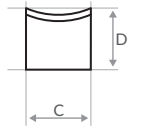
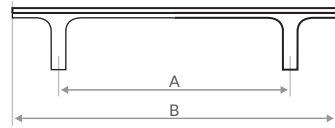
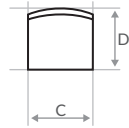
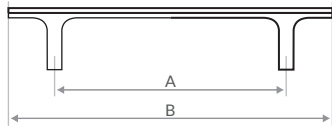

802

805

zamak Acabado finishes

Ref. model

A

B

C

D



 Cromo Brillo
bright chrome

802.160.04
802.224.04
805.160.04
805.224.04

160
224
160
224

200
264
200
264

40
40
40
40

32
32
32
32

15
8
15
8

45
24
45
24

 Níquel Satinado
brush satin nickel

802.160.58
802.224.58
805.160.58
805.224.58

160
224
160
224

200
264
200
264

40
40
40
40

32
32
32
32

15
8
15
8



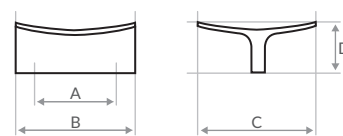
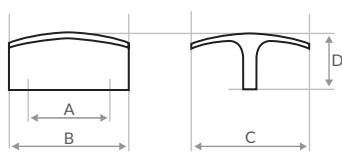
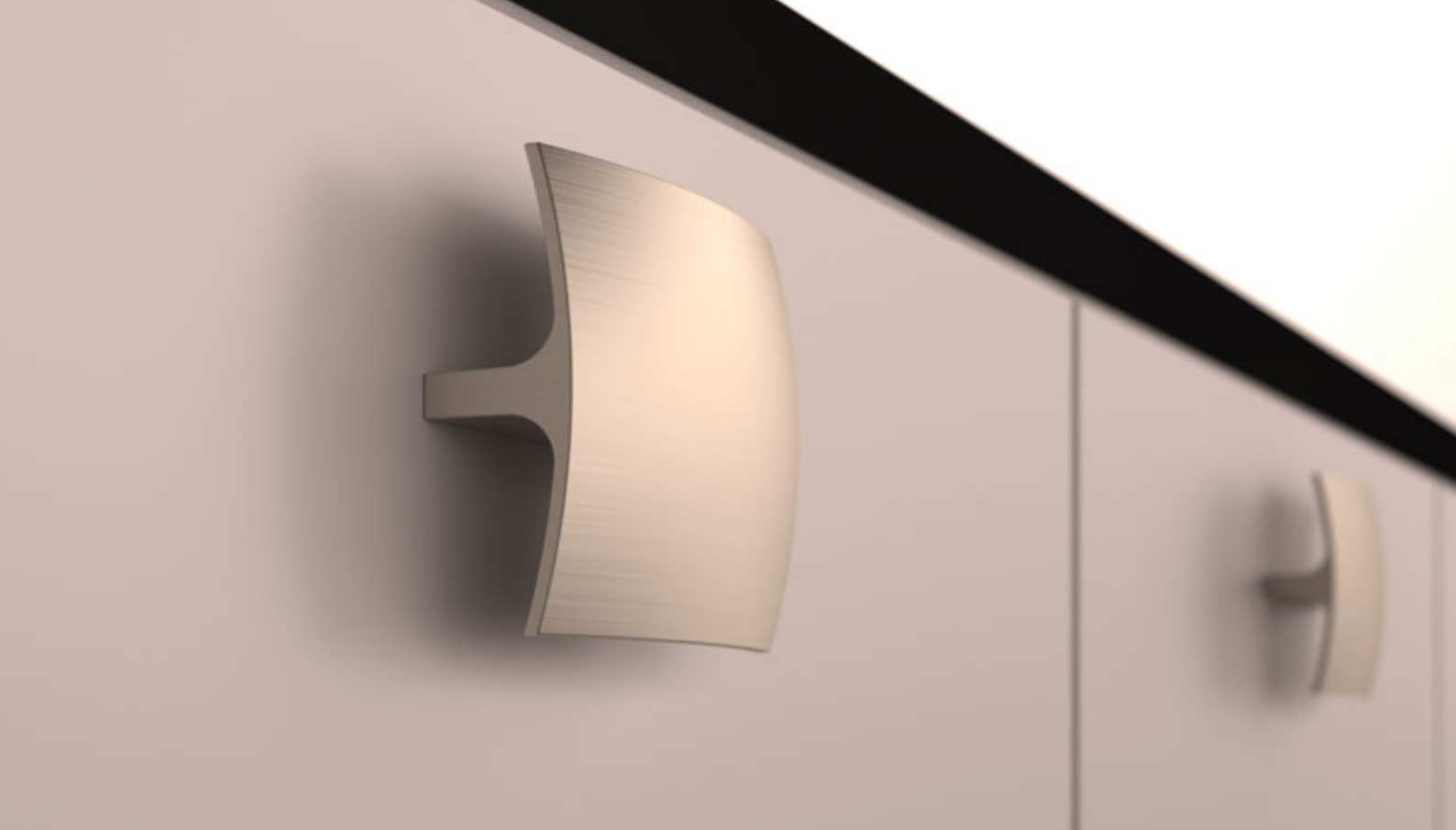

45
24
45
24





803

806

| zamak | Acabado finishes | Ref. model | A | B | C | D |  |  |
|---|--|------------|----|----|----|----|---|---|
|  | Cromo Brillo <i>bright chrome</i> | 803.40.04 | 32 | 40 | 40 | 29 | 50 | 150 |
| | | 803.60.04 | 32 | 60 | 60 | 32 | 30 | 90 |
| | | 803.80.04 | 64 | 80 | 80 | 32 | 20 | 60 |
| | | 806.40.04 | 32 | 40 | 40 | 32 | 50 | 150 |
| 806.60.04 | 32 | 60 | 60 | 32 | 30 | 90 | | |
|  | Cromo Mate <i>mat chrome</i> | 803.40.30 | 32 | 40 | 40 | 29 | 50 | 150 |
| | | 806.40.30 | 32 | 40 | 40 | 32 | 50 | 150 |
|  | Níquel Satinado <i>brush satin nickel</i> | 803.40.58 | 32 | 40 | 40 | 29 | 50 | 150 |
| | | 803.60.58 | 32 | 60 | 60 | 32 | 30 | 90 |
| | | 803.80.58 | 64 | 80 | 80 | 32 | 20 | 60 |
| | | 806.40.58 | 32 | 40 | 40 | 32 | 50 | 150 |
| | | 806.60.58 | 32 | 60 | 60 | 32 | 30 | 90 |

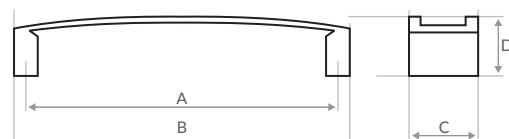
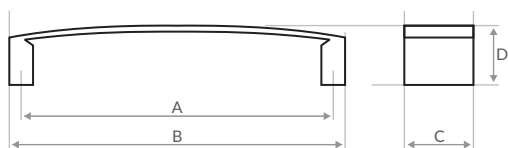

380

380H

aluminio

Acabado finishes

Ref. model

A

B

C

D



Cromo Brillo
bright chrome

380 .160.04
380H.160.04

160
160

170
170

35
35

30
30

10
10

30
30



Cromo mate
mat chrome

380 .160.30
380H.160.30

160
160

170
170

35
35

30
30

10
10

30
30



Níquel Satinado
brush satin nickel

380 .160.58
380H.160.58

160
160

170
170

35
35

30
30



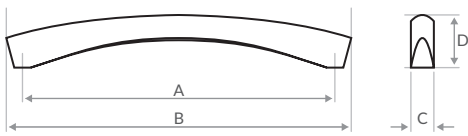

10
10

30
30







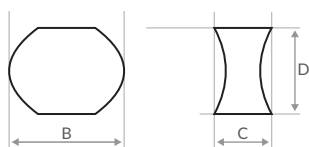

378

| zamak | Acabado finishes | Ref. model | A | B | C | D |  |  |
|---|--|------------|-----|-----|----|----|---|---|
|  | Cromo Brillo <i>bright chrome</i> | 378.096.04 | 96 | 104 | 10 | 25 | 50 | 200 |
| | | 378.128.04 | 128 | 140 | 11 | 28 | 30 | 120 |
| | | 378.160.04 | 160 | 175 | 13 | 29 | 30 | 90 |
| | | 378.192.04 | 192 | 210 | 14 | 32 | 25 | 75 |
| | | 378.256.04 | 256 | 280 | 14 | 35 | 25 | 75 |
| | | 378.384.04 | 384 | 408 | 14 | 38 | 25 | 75 |
|  | Cromo Mate <i>mat chrome</i> | 378.128.30 | 128 | 140 | 11 | 28 | 30 | 120 |
| | | 378.160.30 | 160 | 175 | 13 | 29 | 30 | 90 |
| | | 378.192.30 | 192 | 210 | 14 | 32 | 25 | 75 |
| | | 378.256.30 | 256 | 280 | 14 | 35 | 25 | 75 |
| | | 378.384.30 | 384 | 408 | 14 | 38 | 25 | 75 |
|  | Níquel satinado <i>brush satin nickel</i> | 378.128.58 | 128 | 140 | 11 | 28 | 30 | 120 |
| | | 378.160.58 | 160 | 175 | 13 | 29 | 30 | 90 |
| | | 378.192.58 | 192 | 210 | 14 | 32 | 25 | 75 |
| | | 378.256.58 | 256 | 280 | 14 | 35 | 25 | 75 |
| | | 378.384.58 | 384 | 408 | 14 | 38 | 25 | 75 |





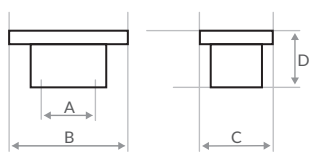

807

| zamak | Acabado finishes | Ref. model | A | B | C | D |  |  |
|---|---|------------|---|----|----|----|---|---|
|  | Cromo Brillo <i>bright chrome</i> | 807.040.04 | - | 40 | 20 | 30 | 60 | 180 |
|  | Cromo Mate <i>mat chrome</i> | 807.040.30 | - | 40 | 20 | 30 | 60 | 180 |
|  | Níquel Satinado <i>brush satin nickel</i> | 807.040.58 | - | 40 | 20 | 30 | 60 | 180 |





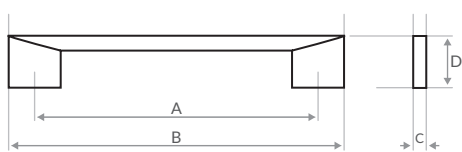
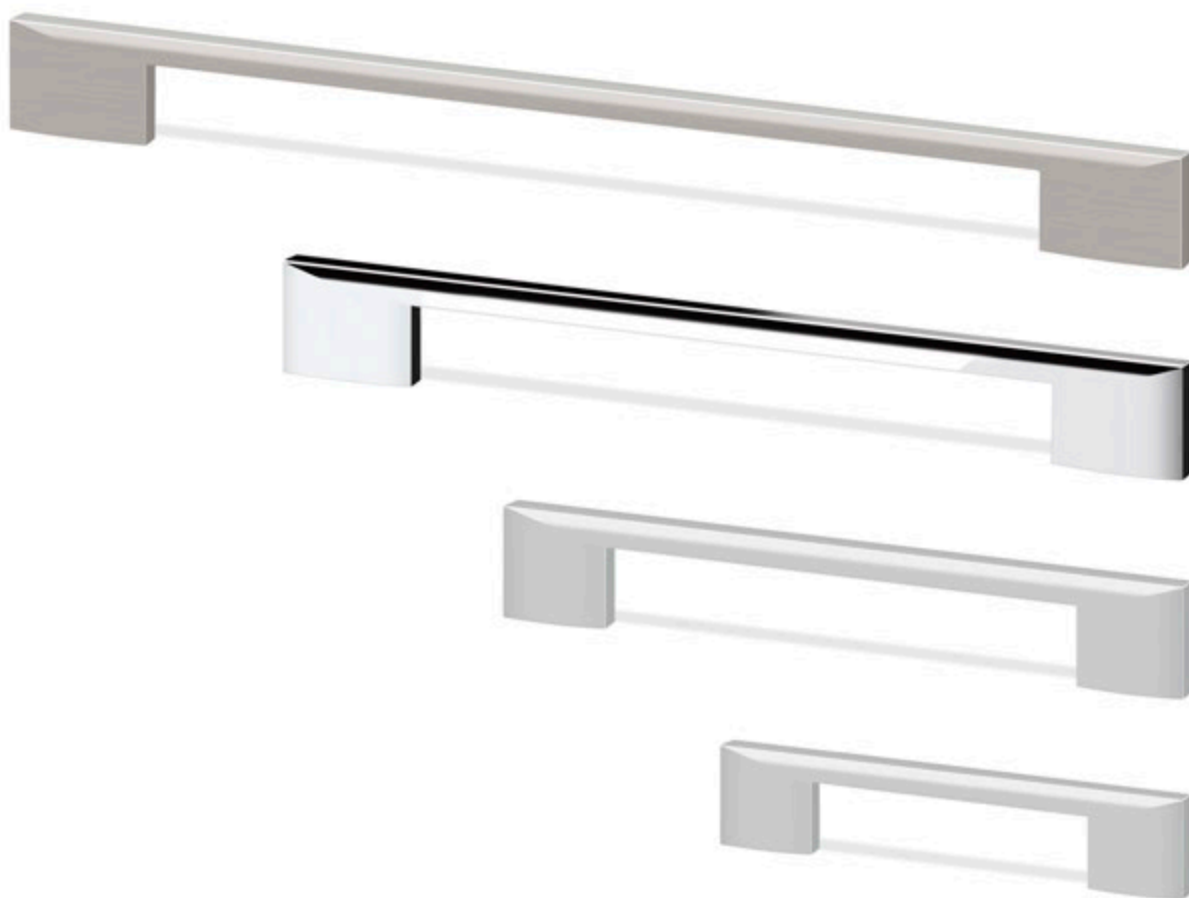

576

| zamak | Acabado finishes | Ref. model | A | B | C | D |  |  |
|---|---|------------|----|----|----|----|---|---|
|  | Cromo Brillo <i>bright chrome</i> | 576.044.04 | 16 | 44 | 27 | 21 | 25 | 100 |
|  | Cromo Mate <i>mat chrome</i> | 576.044.30 | 16 | 44 | 27 | 21 | 25 | 100 |
|  | Níquel Satinado <i>brush satin nickel</i> | 576.044.58 | 16 | 44 | 27 | 21 | 25 | 100 |



377





| zamak | Acabado finishes | Ref. model | A | B | C | D |  |  |
|---|--|------------|-----|-----|---|----|---|---|
|  | Cromo Brillo <i>bright chrome</i> | 377.160.04 | 160 | 187 | 7 | 30 | 40 | 120 |
| | | 377.192.04 | 192 | 226 | 7 | 33 | 30 | 90 |
| | | 377.240.04 | 240 | 280 | 8 | 35 | 25 | 75 |
| | | 377.352.04 | 352 | 400 | 8 | 35 | 25 | 75 |
|  | Cromo Mate <i>mat chrome</i> | 377.160.30 | 160 | 187 | 7 | 30 | 40 | 120 |
| | | 377.192.30 | 192 | 226 | 7 | 33 | 30 | 90 |
| | | 377.240.30 | 240 | 280 | 8 | 35 | 25 | 75 |
| | | 377.352.30 | 352 | 400 | 8 | 35 | 25 | 75 |
|  | Níquel Satinado <i>brush satin nickel</i> | 377.160.58 | 160 | 187 | 7 | 30 | 40 | 120 |
| | | 377.192.58 | 192 | 226 | 7 | 33 | 30 | 90 |
| | | 377.240.58 | 240 | 280 | 8 | 35 | 25 | 75 |
| | | 377.352.58 | 352 | 400 | 8 | 35 | 25 | 75 |

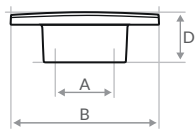

SACA LO MEJOR DE TI





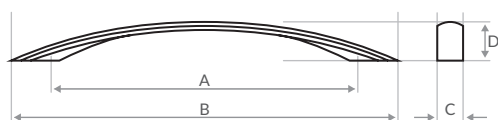

376

| zamak | Acabado finishes | Ref. model | A | B | C | D |  |  |
|---|---|------------|----|----|---|----|---|---|
|  | Cromo Brillo <i>bright chrome</i> | 376.075.04 | 32 | 75 | - | 25 | 25 | 100 |
|  | Cromo Mate <i>mat chrome</i> | 376.075.30 | 32 | 75 | - | 25 | 25 | 100 |
|  | Níquel Satinado <i>brush satin nickel</i> | 376.075.58 | 32 | 75 | - | 25 | 25 | 100 |





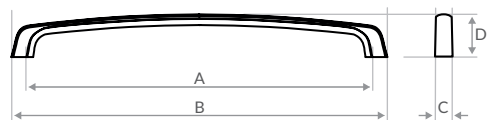

375

| zamak | Acabado finishes | Ref. model | A | B | C | D |  |  |
|---|---|------------|-----|-----|----|----|---|---|
|  | Cromo Brillo <i>bright chrome</i> | 375.192.04 | 192 | 240 | 15 | 24 | 25 | 75 |
|  | Cromo Mate <i>mat chrome</i> | 375.192.30 | 192 | 240 | 15 | 24 | 25 | 75 |
|  | Níquel Satinado <i>brush satin nickel</i> | 375.192.58 | 192 | 240 | 15 | 24 | 25 | 75 |





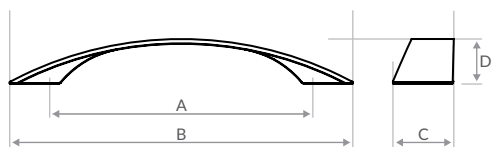

374

| zamak | Acabado finishes | Ref. model | A | B | C | D |  |  |
|---|---|--------------------------|------------|------------|----------|----------|---|---|
|  | Cromo Brillo <i>bright chrome</i> | 374.192.04 374.240.04 | 192 240 | 210 258 | 10 10 | 26 28 | 25 25 | 75 75 |
|  | Cromo Mate <i>mat chrome</i> | 374.192.30 374.240.30 | 192 240 | 210 258 | 10 10 | 26 28 | 25 25 | 75 75 |
|  | Níquel Satinado <i>brush satin nickel</i> | 374.192.58 374.240.58 | 192 240 | 210 258 | 10 10 | 26 28 | 25 25 | 75 75 |





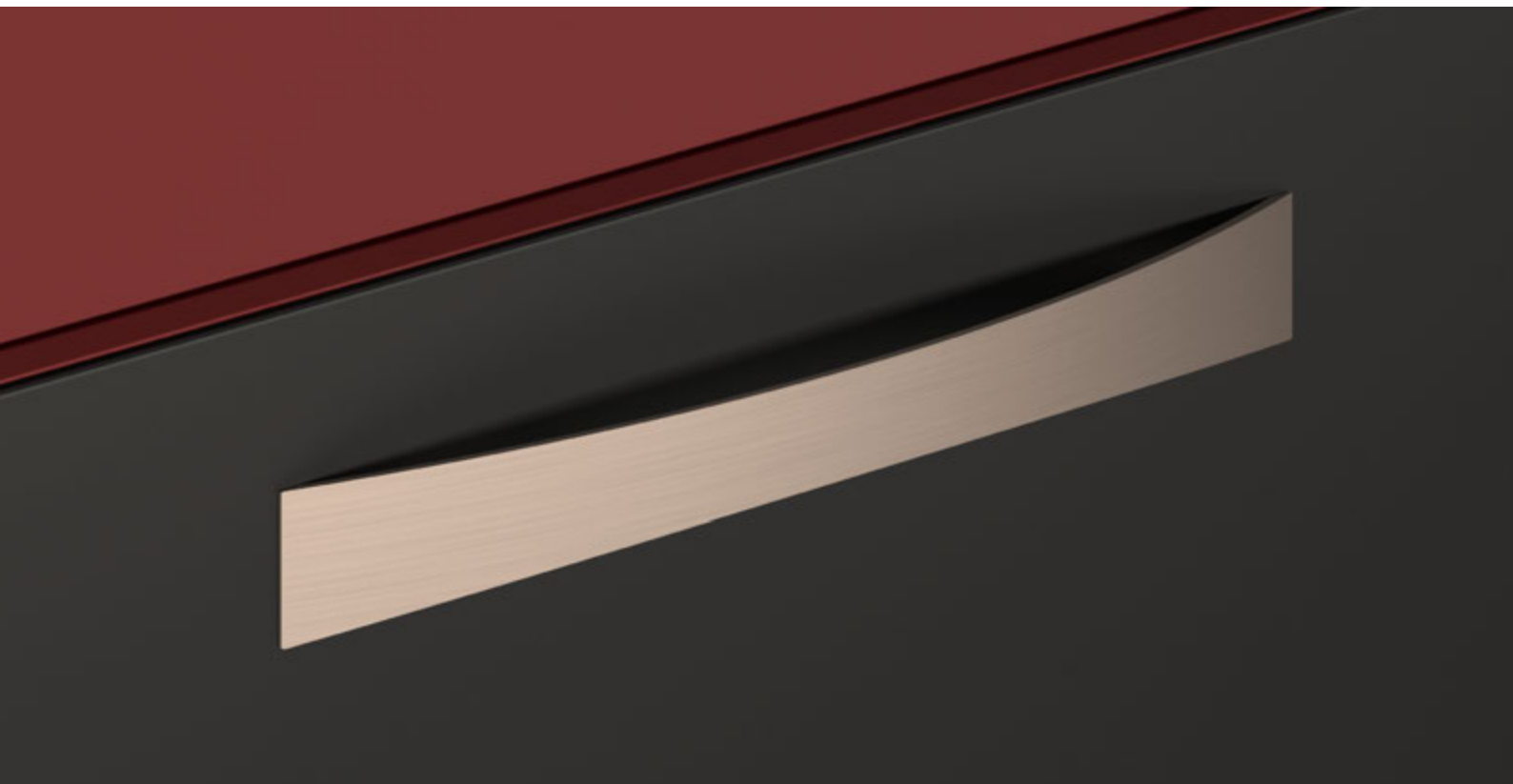

373

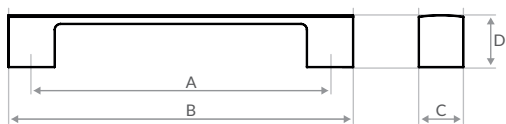
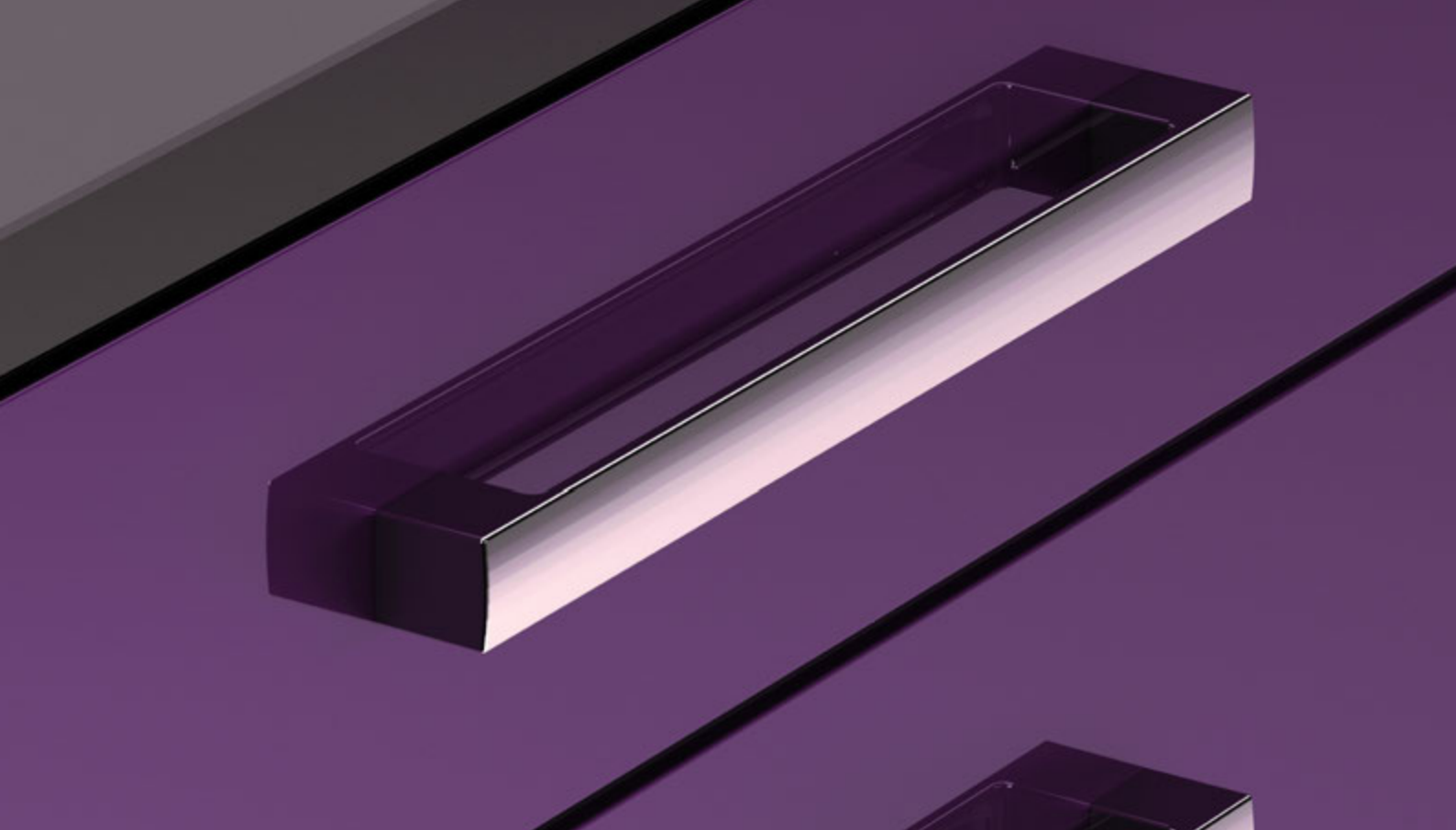
| zamak | Acabado finishes | Ref. model | A | B | C | D |  |  |
|---|--|------------|-----|-----|----|----|---|---|
|  | Cromo Brillo <i>bright chrome</i> | 373.160.04 | 160 | 215 | 37 | 26 | 35 | 140 |
| | | 373.256.04 | 256 | 330 | 37 | 29 | 25 | 75 |
|  | Cromo Mate <i>mat chrome</i> | 373.160.30 | 160 | 215 | 37 | 26 | 35 | 140 |
| | | 373.256.30 | 256 | 330 | 37 | 29 | 25 | 75 |
|  | Níquel Satinado <i>brush satin nickel</i> | 373.160.58 | 160 | 215 | 37 | 26 | 35 | 140 |
| | | 373.256.58 | 256 | 330 | 37 | 29 | 25 | 75 |







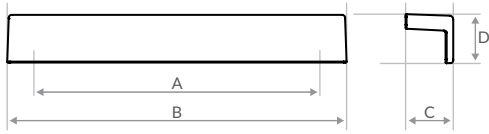
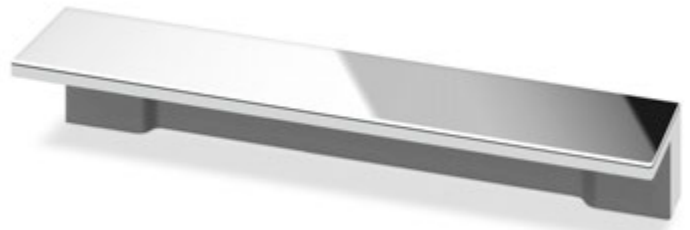

370

| zamak | Acabado finishes | Ref. model | A | B | C | D |  |  |
|---|--|------------|-----|-----|----|----|---|---|
|  | Cromo Brillo <i>bright chrome</i> | 370.128.04 | 128 | 168 | 24 | 28 | 25 | 75 |
| | | 370.160.04 | 160 | 200 | 24 | 28 | 25 | 75 |
| | | 370.192.04 | 192 | 232 | 24 | 28 | 25 | 100 |
|  | Cromo Mate <i>mat chrome</i> | 370.128.30 | 128 | 168 | 24 | 28 | 25 | 75 |
| | | 370.160.30 | 160 | 200 | 24 | 28 | 25 | 75 |
| | | 370.192.30 | 192 | 232 | 24 | 28 | 25 | 100 |
|  | Níquel Satinado <i>brush satin nickel</i> | 370.128.58 | 128 | 168 | 24 | 28 | 25 | 75 |
| | | 370.160.58 | 160 | 200 | 24 | 28 | 25 | 75 |
| | | 370.192.58 | 192 | 232 | 24 | 28 | 25 | 100 |





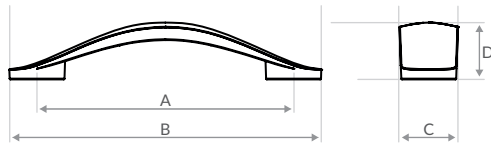

372

| zamak | Acabado finishes | Ref. model | A | B | C | D |  |  |
|---|--|------------|-----|-----|----|----|---|---|
|  | Cromo Brillo <i>bright chrome</i> | 372.096.04 | 96 | 126 | 17 | 17 | 25 | 100 |
| | | 372.128.04 | 128 | 142 | 22 | 22 | 25 | 100 |
| | | 372.160.04 | 160 | 188 | 25 | 25 | 25 | 75 |
|  | Cromo Mate <i>mat chrome</i> | 372.096.30 | 96 | 126 | 17 | 17 | 25 | 100 |
| | | 372.160.30 | 160 | 188 | 25 | 25 | 25 | 75 |
|  | Níquel Satinado <i>brush satin nickel</i> | 372.096.58 | 96 | 126 | 17 | 17 | 25 | 100 |
| | | 372.160.58 | 160 | 188 | 25 | 25 | 25 | 75 |



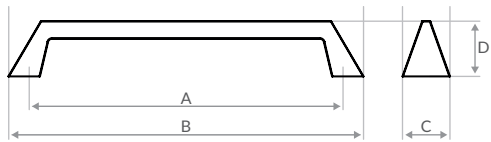

371

| zamak | Acabado finishes | Ref. model | A | B | C | D |  |  |
|---|--|------------|-----|-----|----|----|---|---|
|  | Cromo Brillo <i>bright chrome</i> | 371.096.04 | 96 | 137 | 25 | 27 | 25 | 75 |
| | | 371.160.04 | 160 | 194 | 35 | 36 | 25 | 75 |
|  | Cromo Mate <i>mat chrome</i> | 371.096.30 | 96 | 137 | 25 | 27 | 25 | 75 |
| | | 371.160.30 | 160 | 194 | 35 | 36 | 25 | 75 |
|  | Níquel Satinado <i>brush satin nickel</i> | 371.096.58 | 96 | 137 | 25 | 27 | 25 | 75 |
| | | 371.160.58 | 160 | 194 | 35 | 36 | 25 | 75 |





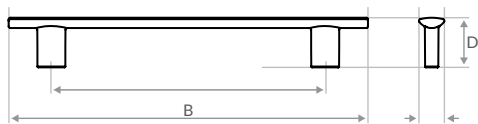
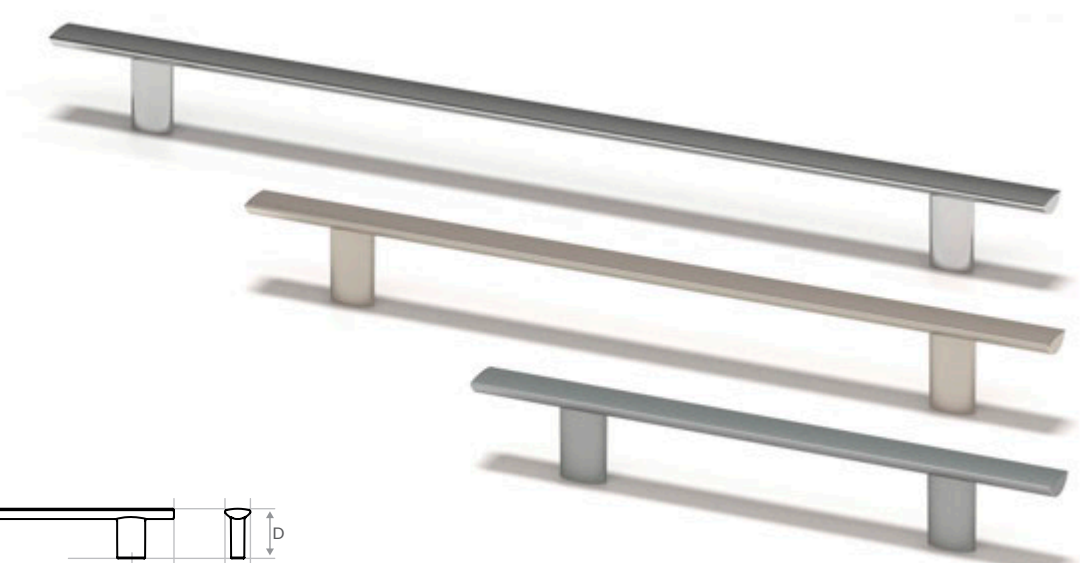

369

| zamak | Acabado finishes | Ref. model | A | B | C | D |  |  |
|---|--------------------------------------|------------|-----|-----|----|----|---|---|
|  | Cromo Brillo <i>bright chrome</i> | 369.160.04 | 160 | 180 | 24 | 29 | 25 | 75 |
| | | 369.160.30 | 160 | 180 | 24 | 29 | 25 | 75 |
| | | 369.160.58 | 160 | 180 | 24 | 29 | 25 | 75 |



368

| zamak | Acabado finishes | Ref. model | A | B | C | D |  |  |
|---|--|------------|-----|-----|----|----|---|---|
|  | Cromo Brillo <i>bright chrome</i> | 368.096.04 | 96 | 146 | 15 | 21 | 25 | 100 |
| | | 368.160.04 | 160 | 210 | 15 | 29 | 30 | 90 |
| | | 368.240.04 | 240 | 298 | 17 | 31 | 20 | 60 |
| | | 368.320.04 | 320 | 398 | 17 | 31 | 25 | 75 |
|  | Cromo Mate <i>mat chrome</i> | 368.096.30 | 96 | 146 | 15 | 21 | 25 | 100 |
| | | 368.160.30 | 160 | 210 | 15 | 29 | 30 | 90 |
| | | 368.240.30 | 240 | 298 | 17 | 31 | 20 | 60 |
| | | 368.320.30 | 320 | 398 | 17 | 31 | 25 | 75 |
|  | Níquel Satinado <i>brush satin nickel</i> | 368.096.58 | 96 | 146 | 15 | 21 | 25 | 100 |
| | | 368.160.58 | 160 | 210 | 15 | 29 | 30 | 90 |
| | | 368.240.58 | 240 | 298 | 17 | 31 | 20 | 60 |
| | | 368.320.58 | 320 | 398 | 17 | 31 | 25 | 75 |

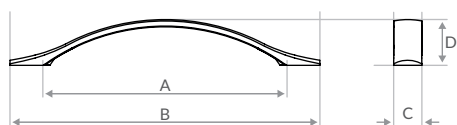

367

zamak

Acabado finishes

Ref. model

A

B

C

D



Cromo Brillo
bright chrome

367.128.04

128

171

18

26

25

75

367.160.04

160

203

20

29

25

75



Cromo Mate
mat chrome

367.128.30

128

171

18

26

25

75

367.160.30

160

203

20

29

25

75



Níquel Satinado
brush satin nickel

367.128.58

128

171

18

26

25

75

367.160.58

160

203

20

29

25

75

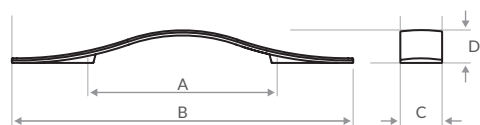

366

zamak

Acabado finishes

Ref. model

A

B

C

D



Cromo Brillo
bright chrome

366.096.04

96

170

25

18

25

75

366.128.04

128

220

27

20

25

75



Cromo Mate
mat chrome

366.096.30

96

170

25

18

25

75

366.128.30

128

220

27

20

25

75



Níquel Satinado
brush satin nickel

366.096.58

96

170

25

18

25

75

366.128.58

128

220

27



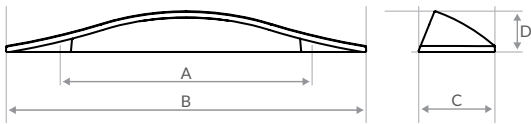

20

25

75





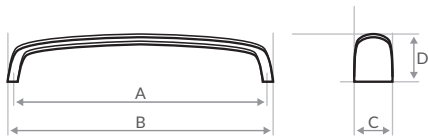

365

| zamak | Acabado finishes | Ref. model | A | B | C | D |  |  |
|---|--|------------|-----|-----|----|----|---|---|
|  | Cromo Brillo <i>bright chrome</i> | 365.016.04 | 16 | 40 | 40 | 16 | 25 | 100 |
| | | 365.064.04 | 64 | 135 | 40 | 19 | 25 | 75 |
| | | 365.128.04 | 128 | 190 | 40 | 22 | 25 | 75 |
| | | 365.224.04 | 224 | 380 | 40 | 24 | 25 | 75 |
|  | Cromo Mate <i>mat chrome</i> | 365.016.30 | 16 | 40 | 40 | 16 | 25 | 100 |
| | | 365.064.30 | 64 | 135 | 40 | 19 | 25 | 75 |
| | | 365.128.30 | 128 | 190 | 40 | 22 | 25 | 75 |
| | | 365.224.30 | 224 | 380 | 40 | 24 | 25 | 75 |
|  | Níquel Satinado <i>brush satin nickel</i> | 365.016.58 | 16 | 40 | 40 | 16 | 25 | 100 |
| | | 365.064.58 | 64 | 135 | 40 | 19 | 25 | 75 |
| | | 365.128.58 | 128 | 190 | 40 | 22 | 25 | 75 |
| | | 365.224.58 | 224 | 380 | 40 | 24 | 25 | 75 |







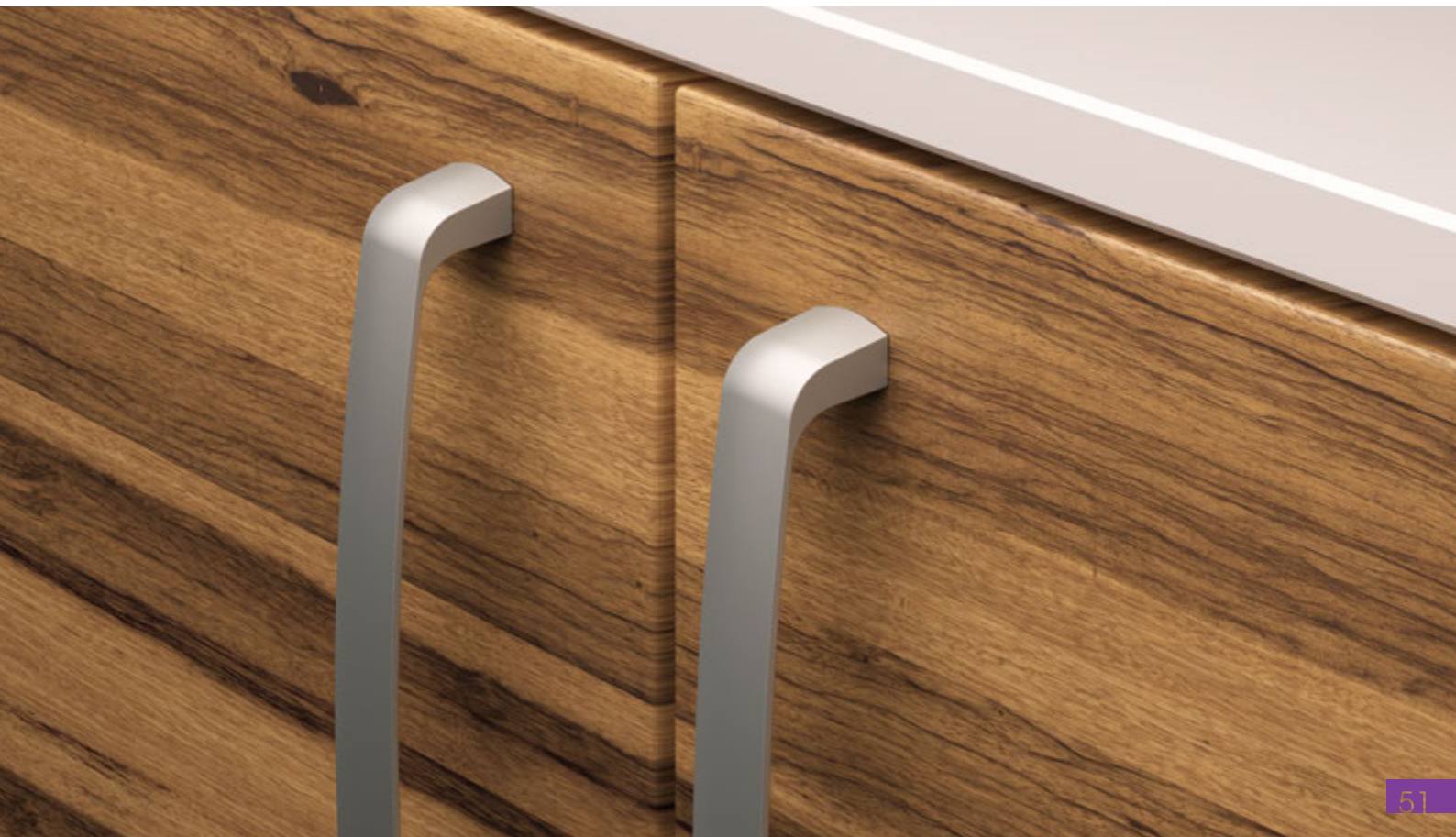

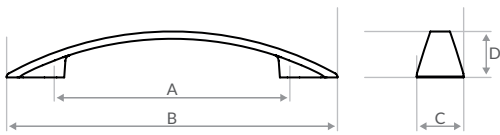
305

| zamak | Acabado finishes | Ref. model | A | B | C | D |  |  |
|---|--|------------|-----|-----|----|----|---|---|
|  | Cromo Brillo <i>bright chrome</i> | 305.096.04 | 96 | 107 | 18 | 19 | 25 | 100 |
| | | 305.160.04 | 160 | 172 | 23 | 24 | 30 | 90 |
| | | 305.192.04 | 192 | 204 | 24 | 25 | 25 | 75 |
|  | Cromo Mate <i>mat chrome</i> | 305.096.30 | 96 | 107 | 18 | 19 | 25 | 100 |
| | | 305.160.30 | 160 | 172 | 23 | 24 | 30 | 90 |
| | | 305.192.30 | 192 | 204 | 24 | 25 | 25 | 75 |
|  | Níquel Satinado <i>brush satin nickel</i> | 305.096.58 | 96 | 107 | 18 | 19 | 25 | 100 |
| | | 305.160.58 | 160 | 172 | 23 | 24 | 30 | 90 |
| | | 305.192.58 | 192 | 204 | 24 | 25 | 25 | 75 |









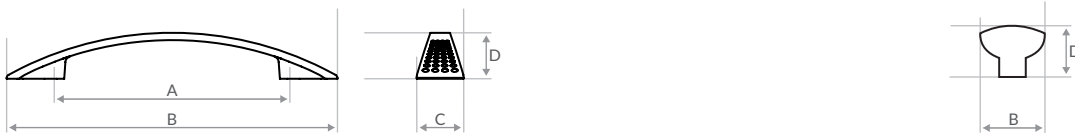

322

| zamak | Acabado finishes | Ref. model | A | B | C | D |  |  |
|---|---|------------|-----|-----|----|----|---|---|
|  | Cromo Brillo <i>bright chrome</i> | 322.128.04 | 128 | 180 | 25 | 25 | 25 | 75 |
|  | Cromo Mate <i>mat chrome</i> | 322.128.30 | 128 | 180 | 25 | 25 | 25 | 75 |
|  | Níquel Satinado <i>brush satin nickel</i> | 322.128.58 | 128 | 180 | 25 | 25 | 25 | 75 |
|  | Níquel Mate <i>mat nickel</i> | 322.128.59 | 128 | 180 | 25 | 25 | 25 | 75 |



321

244

| zamak | Acabado finishes | Ref. model | A | B | C | D |  |  |
|---|---|------------|-----|-----|----|----|---|---|
|  | Cromo Brillo <i>bright chrome</i> | 321.128.04 | 128 | 180 | 25 | 25 | 25 | 75 |
|  | Cromo Mate <i>mat chrome</i> | 321.128.30 | 128 | 180 | 25 | 25 | 25 | 75 |
| | | 244.034.30 | - | 34 | - | 27 | 50 | 150 |
|  | Níquel Satinado <i>brush satin nickel</i> | 321.128.58 | 128 | 180 | 25 | 25 | 25 | 75 |
|  | Níquel Mate <i>mat nickel</i> | 321.128.59 | 128 | 180 | 25 | 25 | 25 | 75 |

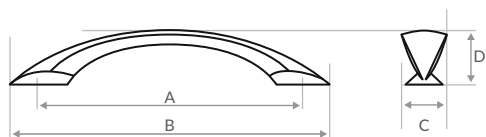

281

zamak

Acabado finishes

Ref. model

A

B

C

D



Cromo Mate
mat chrome

281.096.30
281.128.30

96
128

120
153

21
23

26
25



50
50



150
150

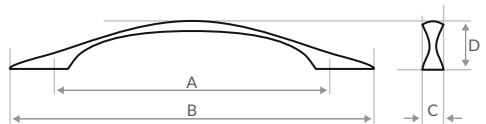

285

zamak

Acabado finishes

Ref. model

A

B

C

D



Cromo Mate
mat chrome

285.128.30

128

160

16

25



50



150



Níquel Mate
mat nickel

285.128.59

128

160

16

25





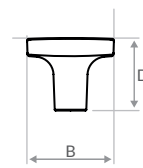
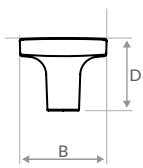

50

150







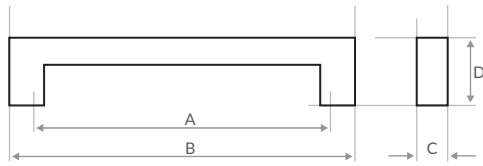

240

241

| zamak | Acabado finishes | Ref. model | A | B | C | D |  |  |
|---|--|------------|---|----|---|----|---|---|
|  | Cromo Brillo <i>bright chrome</i> | 240.024.04 | - | 24 | - | 20 | 100 | 300 |
| | | 240.032.04 | - | 32 | - | 26 | 100 | 300 |
| | | 241.024.04 | - | 24 | - | 20 | 100 | 300 |
| | | 241.032.04 | - | 32 | - | 26 | 100 | 300 |
|  | Cromo Mate <i>mat chrome</i> | 240.024.30 | - | 24 | - | 20 | 100 | 300 |
| | | 240.032.30 | - | 32 | - | 26 | 100 | 300 |
| | | 241.024.30 | - | 24 | - | 20 | 100 | 300 |
| | | 241.032.30 | - | 32 | - | 26 | 100 | 300 |
|  | Níquel Satinado <i>brush satin nickel</i> | 240.024.58 | - | 24 | - | 20 | 100 | 300 |
| | | 240.032.58 | - | 32 | - | 26 | 100 | 300 |
| | | 241.024.58 | - | 24 | - | 20 | 100 | 300 |
| | | 241.032.58 | - | 32 | - | 26 | 100 | 300 |
|  | Níquel Mate <i>mat nickel</i> | 240.024.59 | - | 24 | - | 20 | 100 | 300 |
| | | 240.032.59 | - | 32 | - | 26 | 100 | 300 |
| | | 241.024.59 | - | 24 | - | 20 | 100 | 300 |
| | | 241.032.59 | - | 32 | - | 26 | 100 | 300 |







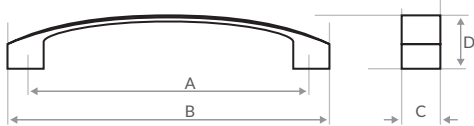

521

| zamak | Acabado finishes | Ref. model | A | B | C | D |  |  |
|---|---|------------|-----|-----|----|----|---|---|
|  | Cromo Brillo <i>bright chrome</i> | 521.160.04 | 160 | 187 | 16 | 35 | 20 | 60 |
|  | Cromo Mate <i>mat chrome</i> | 521.160.30 | 160 | 187 | 16 | 35 | 20 | 60 |
|  | Níquel Satinado <i>brush satin nickel</i> | 521.160.58 | 160 | 187 | 16 | 35 | 20 | 60 |
|  | Níquel Mate <i>mat nickel</i> | 521.160.59 | 160 | 187 | 16 | 35 | 20 | 60 |



520

| zamak | Acabado finishes | Ref. model | A | B | C | D |  |  |
|---|---|------------|-----|-----|----|----|---|---|
|  | Cromo Brillo <i>bright chrome</i> | 520.160.04 | 160 | 178 | 24 | 30 | 25 | 75 |
|  | Cromo Mate <i>mat chrome</i> | 520.160.30 | 160 | 178 | 24 | 30 | 25 | 75 |
|  | Níquel Satinado <i>brush satin nickel</i> | 520.160.58 | 160 | 178 | 24 | 30 | 25 | 75 |
|  | Níquel Mate <i>mat nickel</i> | 520.160.59 | 160 | 178 | 24 | 30 | 25 | 75 |

ALUMINIO

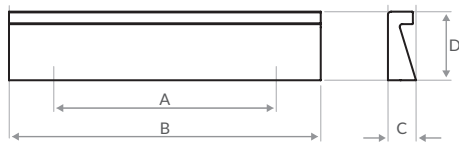

708

aluminio

Acabado finishes

Ref. model

A

B

C

D



Cromo Brillo
bright chrome

708.100.04
708.200.04
708.300.04
708.400.04
708.600.04

64
96
128
160
320

100
200
300
400
600

9
9
9
9
9

22
22
22
22
22

80
50
30
30
20

320
200
120
120
80

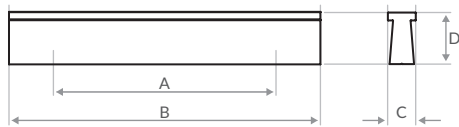

707

aluminio

Acabado finishes

Ref. model

A

B

C

D



Cromo Brillo
bright chrome

707.100.04
707.136.04
707.200.04
707.300.04
707.400.04

64
64*96
96
128
160

100
136
200
300
400

8
8
8
8
8

15
15
15
15
15

80
80
50
30
30

320
320
200
120
120

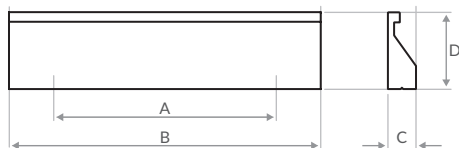

706

aluminio

Acabado finishes

Ref. model

A

B

C

D



Cromo Brillo
bright chrome

706.100.04
706.200.04
706.300.04
706.400.04

64
96
128
160

100
200
300
400

7
7
7
7

20
20
20
20

80
50
30
30

320
200
120
120

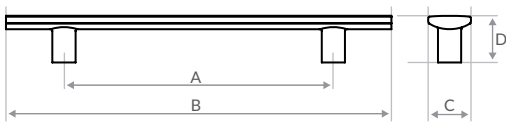

709

aluminio

Acabado finishes

Ref. model

A

B

C

D



Cromo Brillo
bright chrome

709.096.04
709.192.04
709.224.04
709.384.04
709.672.04

96 160 26 27
192 260 26 27
224 310 26 27
384 460 26 27
672 760 26 27

50
30
30
20
20





200
120
120
80
80

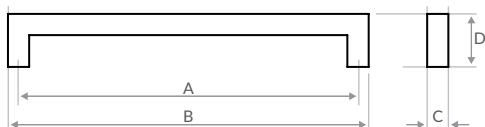

It's all about
QUALITY



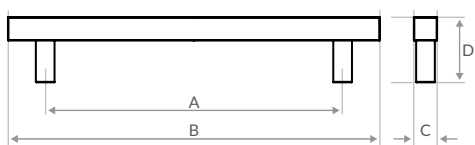
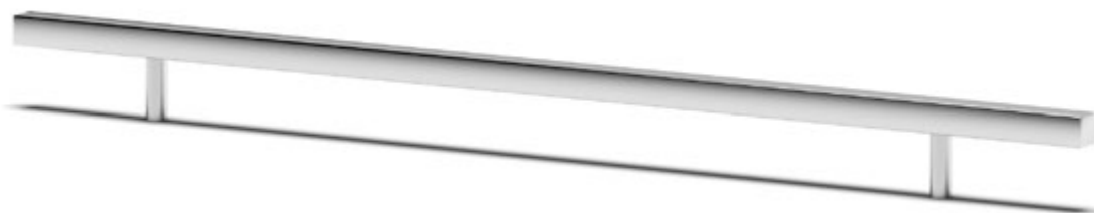

704

| aluminio | Acabado finishes | Ref. model | A | B | C | D |  |  |
|---|--------------------------------------|------------|---------|-----|----|----|---|---|
|  | Cromo Brillo <i>bright chrome</i> | 704.140.04 | 128 | 140 | 12 | 30 | 25 | 75 |
| | | 704.204.04 | 192 | 204 | 12 | 30 | 25 | 75 |
| | | 704.292.04 | 280 | 292 | 12 | 30 | 25 | 75 |
| | | 704.392.04 | 380 | 392 | 12 | 30 | 25 | 75 |
| | | 704.592.04 | 580 | 592 | 12 | 30 | 25 | 75 |
| | | 704.792.04 | 390*780 | 792 | 12 | 30 | 25 | 75 |
|  | Aluminio Plata anodized aluminium | 704.140.31 | 128 | 140 | 12 | 30 | 25 | 75 |
| | | 704.204.31 | 192 | 204 | 12 | 30 | 25 | 75 |
| | | 704.292.31 | 280 | 292 | 12 | 30 | 25 | 75 |
| | | 704.392.31 | 380 | 392 | 12 | 30 | 25 | 75 |
| | | 704.592.31 | 580 | 592 | 12 | 30 | 25 | 75 |
| | | 704.792.31 | 390*780 | 792 | 12 | 30 | 25 | 75 |



703

| aluminio | Acabado finishes | Ref. model | A | B | C | D |  |  |
|---|--------------------------------------|------------|---------|-----|----|----|---|---|
|  | Cromo Brillo <i>bright chrome</i> | 703.160.04 | 96 | 160 | 10 | 28 | 20 | 60 |
| | | 703.192.04 | 128 | 192 | 10 | 28 | 20 | 60 |
| | | 703.320.04 | 256 | 320 | 10 | 28 | 20 | 60 |
| | | 703.420.04 | 356 | 420 | 10 | 28 | 20 | 60 |
| | | 703.620.04 | 556 | 620 | 10 | 28 | 20 | 60 |
| | | 703.720.04 | 656*328 | 720 | 10 | 28 | 20 | 60 |

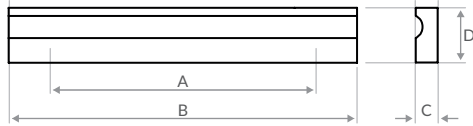
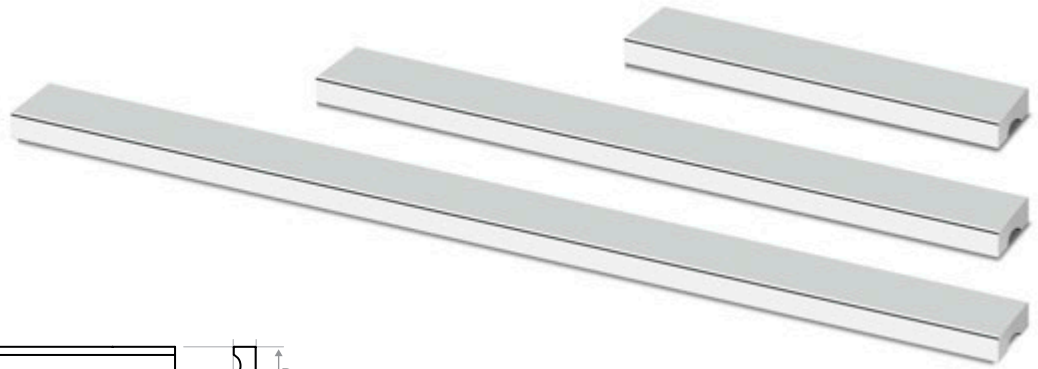

702

aluminio

Acabado finishes

Ref. model

A

B

C

D



Cromo Brillo
bright chrome

702.150.04

96

150

8

20

25

75

702.200.04

160

200

8

20

25

75

702.300.04

256

300

8

20

25

75

702.400.04

320

400

8

20

25

75

702.600.04

240*480

600

8

20

25

75

702.800.04

320*640

800

8

20

25

75

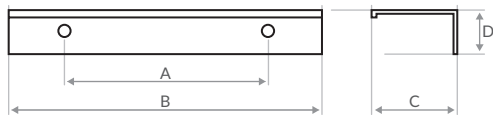

701

aluminio

Acabado finishes

Ref. model

A

B

C

D



Cromo Brillo
bright chrome

701.045.04

32

45

42

20

20

60

701.104.04

64

104

42

20

20

60

701.168.04

96

168

42

20

20

60

701.200.04

128

200

42

20

20

60



Aluminio Plata
anodized aluminium

701.045.31

32

45

42

20

20

60

701.104.31

64

104

42

20

20

60

701.168.31

96

168

42

20

20

60

701.200.31

128

200

42





20

20

60





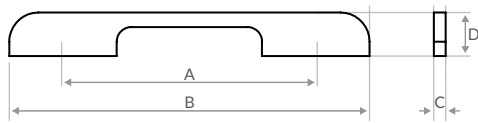
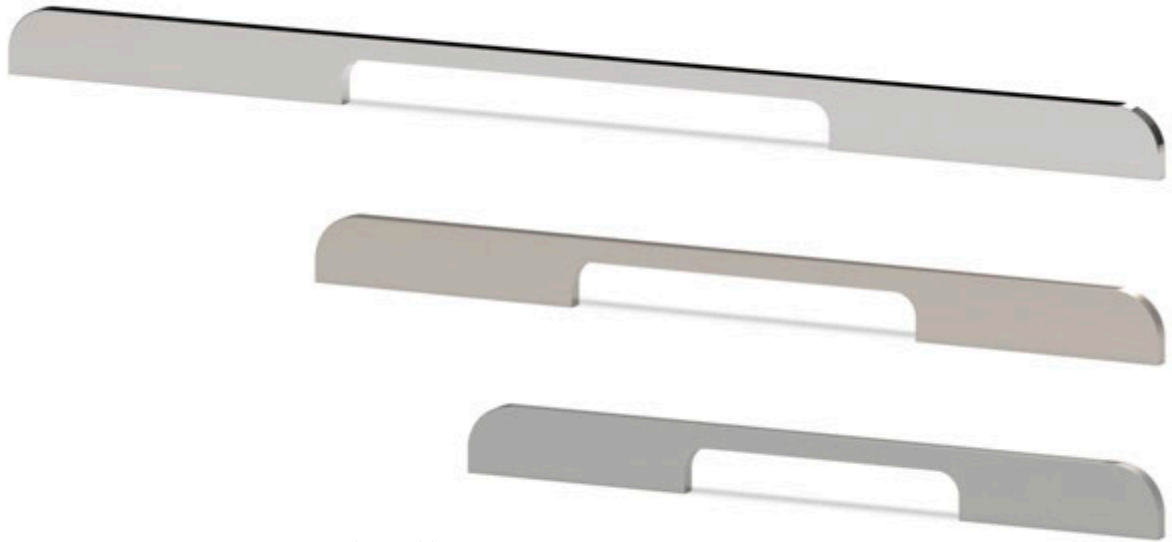

397

| aluminio | Acabado finishes | Ref. model | A | B | C | D |  |  |
|---|---|------------|---------|-----|----|----|---|---|
|  | Cromo Brillo <i>bright chrome</i> | 397.064.04 | 64 | 96 | 12 | 27 | 20 | 60 |
| | | 397.192.04 | 192 | 212 | 12 | 27 | 20 | 60 |
| | | 397.256.04 | 256 | 276 | 12 | 27 | 20 | 60 |
| | | 397.396.04 | 288 | 396 | 12 | 27 | 20 | 60 |
| | | 397.596.04 | 240*480 | 596 | 12 | 27 | 20 | 60 |
| | | 397.796.04 | 320*640 | 796 | 12 | 27 | 20 | 60 |
|  | Aluminio Plata <i>anodized aluminium</i> | 397.064.31 | 64 | 96 | 12 | 27 | 20 | 60 |
| | | 397.192.31 | 192 | 212 | 12 | 27 | 20 | 60 |
| | | 397.256.31 | 256 | 276 | 12 | 27 | 20 | 60 |





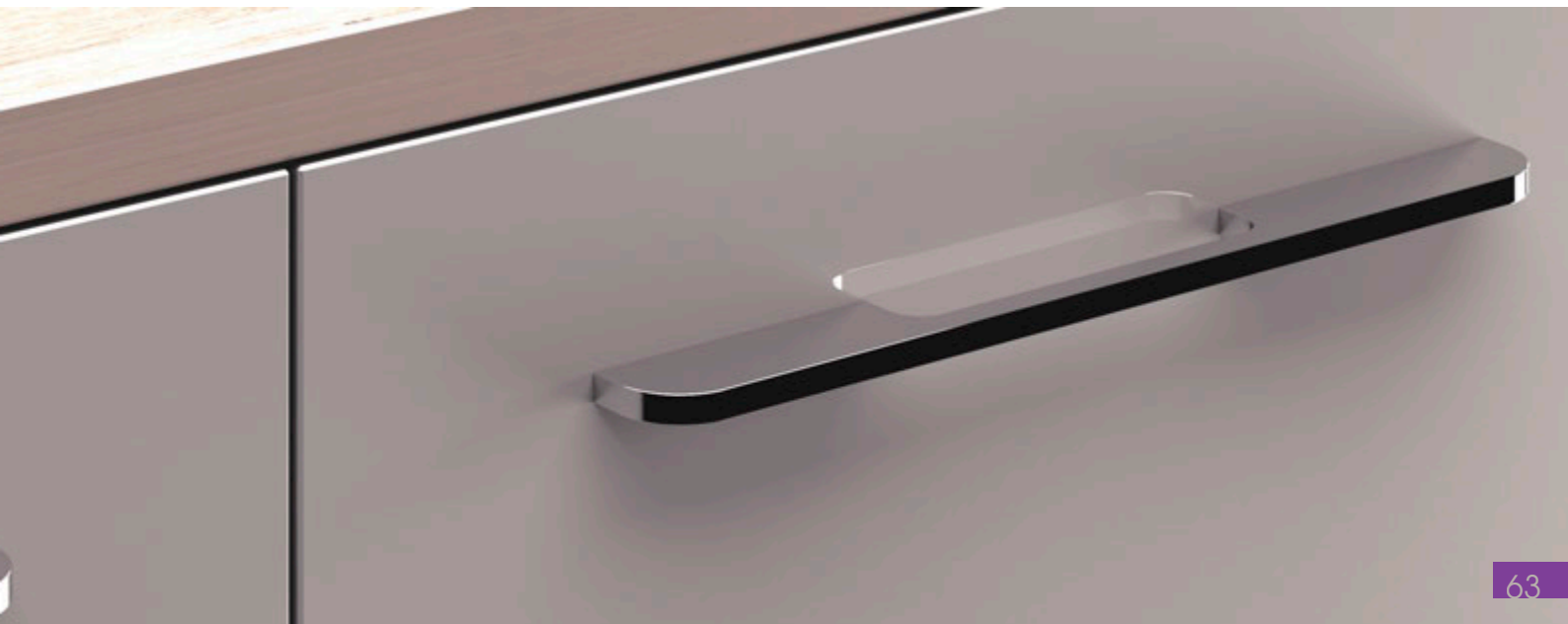

396

| aluminio | Acabado finishes | Ref. model | A | B | C | D |  |  |
|---|------------------|------------|---------|-----|---|----|---|---|
|  Cromo Brillo <i>bright chrome</i> | | 396.096.04 | 64 | 96 | 8 | 30 | 20 | 60 |
| | | 396.246.04 | 192 | 246 | 8 | 30 | 20 | 60 |
| | | 396.296.04 | 240 | 296 | 8 | 30 | 20 | 60 |
| | | 396.396.04 | 288 | 396 | 8 | 30 | 20 | 60 |
| | | 396.496.04 | 256*460 | 496 | 8 | 30 | 20 | 60 |
| | | 396.596.04 | 290*560 | 596 | 8 | 30 | 20 | 60 |
| | | 396.696.04 | 320*660 | 696 | 8 | 30 | 20 | 60 |
| | | 396.796.04 | 380*760 | 796 | 8 | 30 | 20 | 60 |
|  Aluminio Plata <i>anodized aluminium</i> | | 396.096.31 | 64 | 96 | 8 | 30 | 20 | 60 |
| | | 396.246.31 | 192 | 246 | 8 | 30 | 20 | 60 |
| | | 396.296.31 | 240 | 296 | 8 | 30 | 20 | 60 |
| | | 396.396.31 | 288 | 396 | 8 | 30 | 20 | 60 |
| | | 396.496.31 | 256*460 | 496 | 8 | 30 | 20 | 60 |
| | | 396.596.31 | 290*560 | 596 | 8 | 30 | 20 | 60 |
| | | 396.696.31 | 320*660 | 696 | 8 | 30 | 20 | 60 |
| | | 396.796.31 | 380*760 | 796 | 8 | 30 | 20 | 60 |
|  Níquel Satinado <i>brush satin nickel</i> | | 396.096.58 | 64 | 96 | 8 | 30 | 20 | 60 |
| | | 396.246.58 | 192 | 246 | 8 | 30 | 20 | 60 |
| | | 396.296.58 | 240 | 296 | 8 | 30 | 20 | 60 |
| | | 396.396.58 | 288 | 396 | 8 | 30 | 20 | 60 |
| | | 396.496.58 | 256*460 | 496 | 8 | 30 | 20 | 60 |
| | | 396.596.58 | 290*560 | 596 | 8 | 30 | 20 | 60 |
| | | 396.696.58 | 320*660 | 696 | 8 | 30 | 20 | 60 |
| | | 396.796.58 | 380*760 | 796 | 8 | 30 | 20 | 60 |







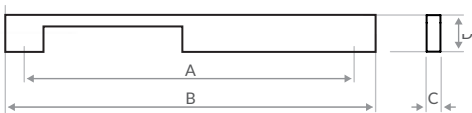

399

| aluminio | Acabado finishes | Ref. model | A | B | C | D |  |  |
|---|--|------------|-----|-----|---|----|---|---|
|  | Cromo Brillo <i>bright chrome</i> | 399.064.04 | 64 | 96 | 8 | 32 | 20 | 60 |
| | | 399.240.04 | 240 | 320 | 8 | 32 | 20 | 60 |
|  | Aluminio Plata <i>anodized aluminium</i> | 399.064.31 | 64 | 96 | 8 | 32 | 20 | 60 |
| | | 399.240.31 | 240 | 320 | 8 | 32 | 20 | 60 |
|  | Níquel Satinado <i>brush satin nickel</i> | 399.064.58 | 64 | 96 | 8 | 32 | 20 | 60 |
| | | 399.240.58 | 240 | 320 | 8 | 32 | 20 | 60 |



400

| aluminio | Acabado finishes | Ref. model | A | B | C | D |  |  |
|---|--|------------|-----|-----|---|----|---|---|
|  | Cromo Brillo <i>bright chrome</i> | 400.064.04 | 64 | 96 | 8 | 32 | 20 | 60 |
| | | 400.240.04 | 240 | 320 | 8 | 32 | 20 | 60 |
|  | Aluminio Plata <i>anodized aluminium</i> | 400.064.31 | 64 | 96 | 8 | 32 | 20 | 60 |
| | | 400.240.31 | 240 | 320 | 8 | 32 | 20 | 60 |
|  | Níquel Satinado <i>brush satin nickel</i> | 400.064.58 | 64 | 96 | 8 | 32 | 20 | 60 |
| | | 400.240.58 | 240 | 320 | 8 | 32 | 20 | 60 |

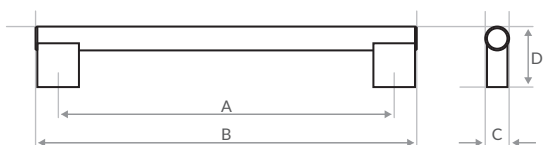

389

aluminio

Acabado finishes

Ref. model

A

B

C

D



Aluminio Plata
anodized aluminium

389.192.31
389.392.31
389.492.31
389.592.31
389.692.31

192
392
492
592
692

212
312
512
612
712

14
14
14
14
14

44
44
44
44
44

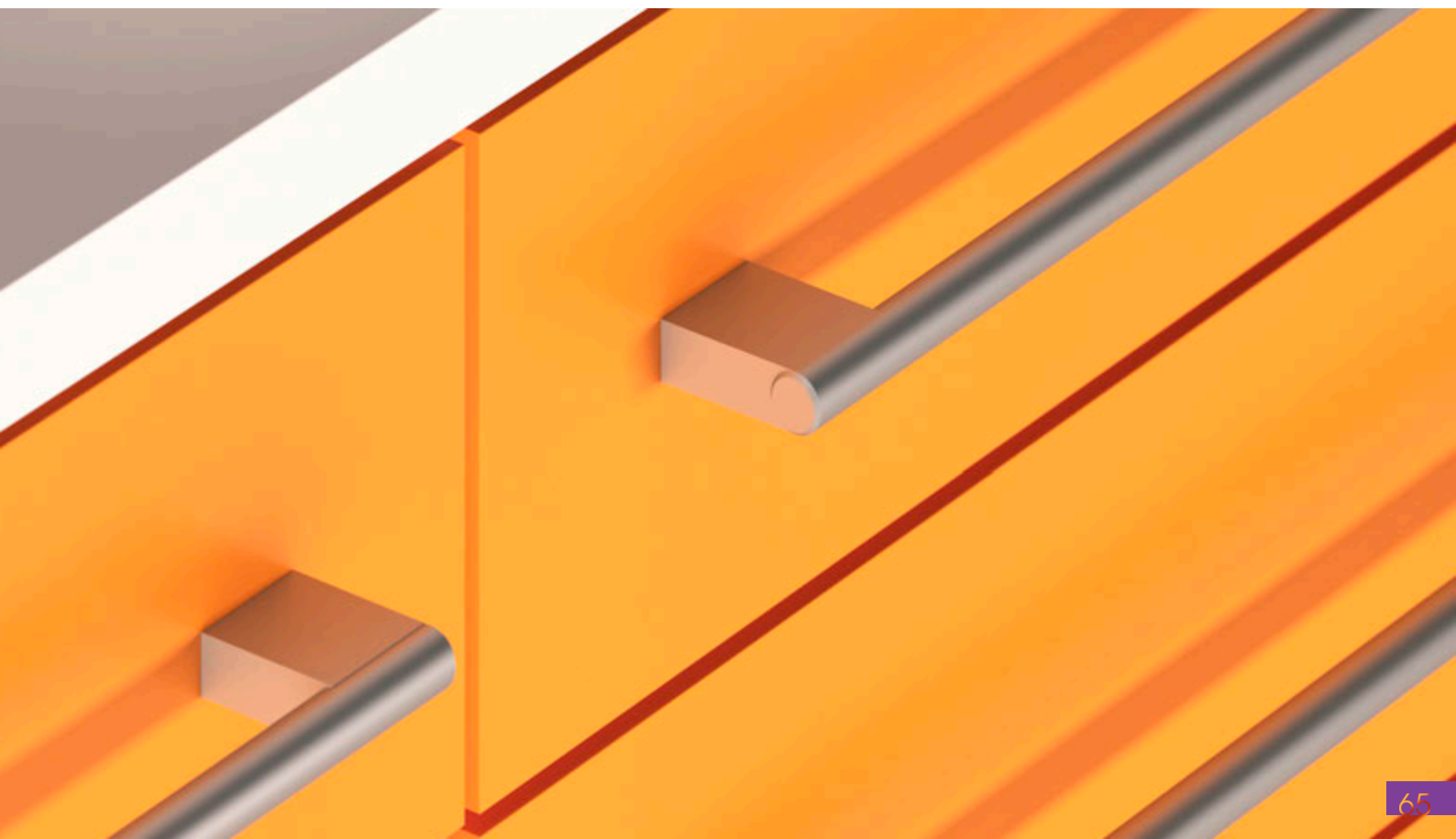

20
20
20
20
20

60
60
60
60
60

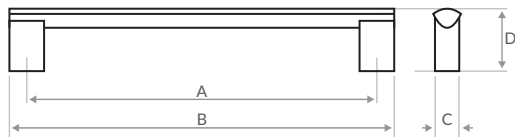
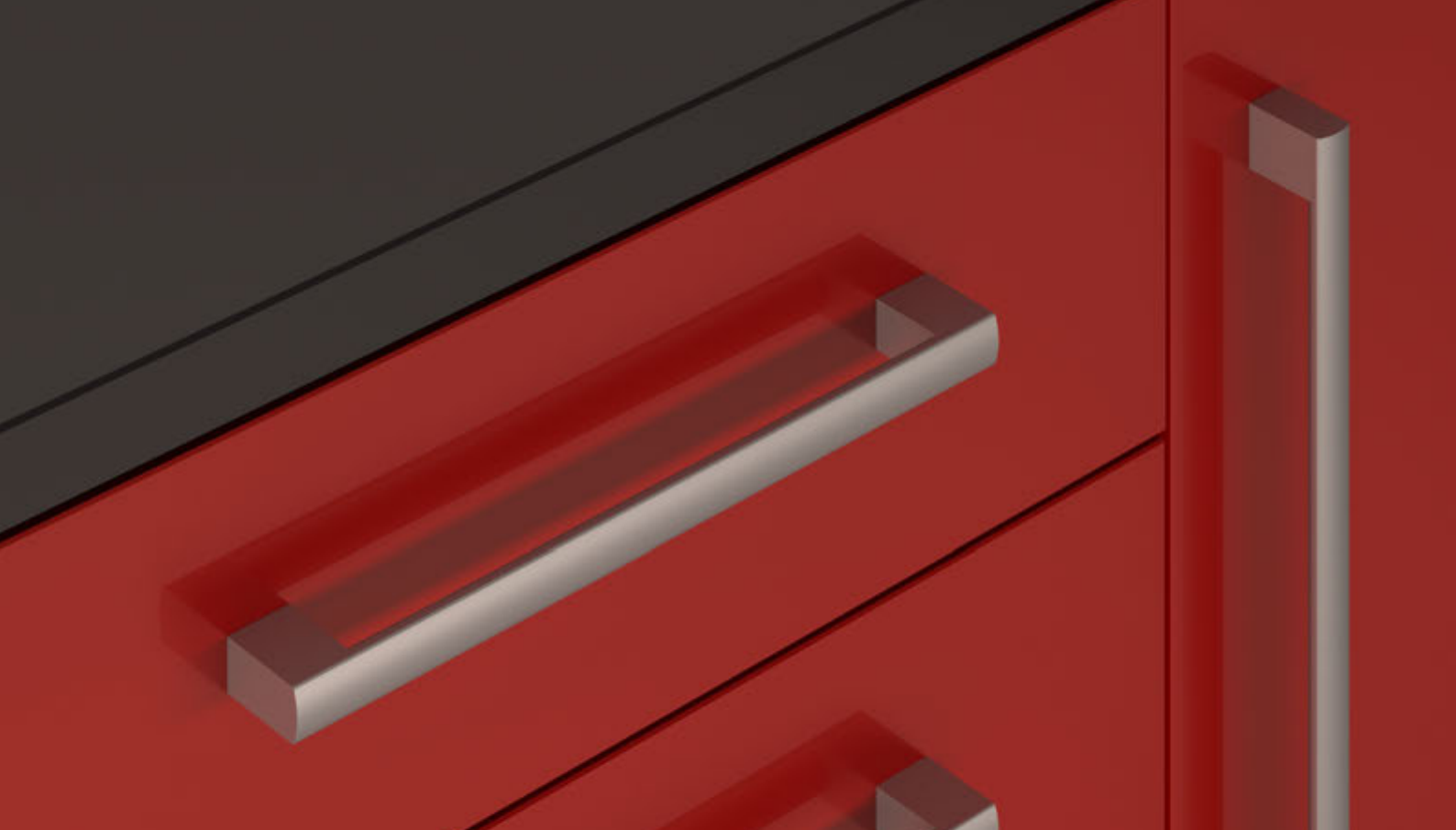



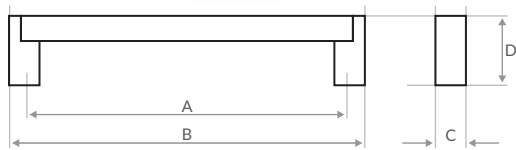

385

| aluminio | Acabado finishes | Ref. model | A | B | C | D |  |  | |
|---|---|-------------|------|------|------|----|---|---|----|
|  | Aluminio Plata <i>anodized aluminium</i> | 385. 128.31 | 200 | 128 | 148 | 16 | 36 | 15 | 45 |
| | | 385. 160.31 | 250 | 160 | 180 | 16 | 36 | 15 | 45 |
| | | 385. 192.31 | 300 | 192 | 212 | 16 | 36 | 15 | 45 |
| | | 385. 242.31 | 350 | 242 | 262 | 16 | 36 | 15 | 45 |
| | | 385. 292.31 | 400 | 292 | 312 | 16 | 36 | 15 | 45 |
| | | 385. 342.31 | 450 | 342 | 362 | 16 | 36 | 15 | 45 |
| | | 385. 392.31 | 500 | 392 | 412 | 16 | 36 | 15 | 45 |
| | | 385. 492.31 | 600 | 492 | 512 | 16 | 36 | 15 | 45 |
| | | 385. 592.31 | 700 | 592 | 612 | 16 | 36 | 15 | 45 |
| | | 385. 692.31 | 800 | 692 | 712 | 16 | 36 | 15 | 45 |
| | | 385. 792.31 | 900 | 792 | 812 | 16 | 36 | 15 | 45 |
| | | 385. 892.31 | 1000 | 892 | 912 | 16 | 36 | 15 | 45 |
| | | 385. 992.31 | 1100 | 992 | 1012 | 16 | 36 | 15 | 45 |
| | | 385.1092.31 | 1200 | 1092 | 1112 | 16 | 36 | 15 | 45 |



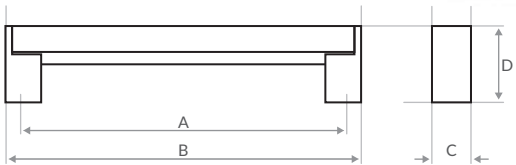
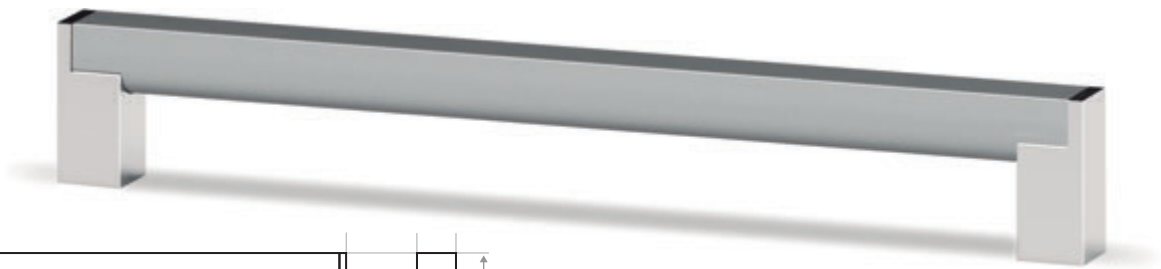

383

| aluminio | Acabado finishes | Ref. model | A | B | C | D |  |  |
|---|---|-----------------------|--|-----|----|----|---|---|
|  | Aluminio Plata <i>anodized aluminium</i> | 383.128.31 | 128 | 149 | 15 | 36 | 15 | 45 |
| | | 383.192.31 | 192 | 213 | 15 | 36 | 15 | 45 |
| | | 383.292.31 | 292 | 313 | 15 | 36 | 15 | 45 |
| | | 383.392.31 | 392 | 413 | 15 | 36 | 15 | 45 |
| | | 383.492.31 | 492 | 513 | 15 | 36 | 15 | 45 |
| | | 383.592.31 | 592 | 613 | 15 | 36 | 15 | 45 |
| | | 383.792.31 | 792 | 813 | 15 | 36 | 15 | 45 |
| | | 383.3000.31 383.63 | Barra de 3mtrs. / 3mtrs. Bar Terminales Cromo Look / Look Chrome Ends | | | | 10 | 50 |



381

| aluminio | Acabado finishes | Ref. model | A | B | C | D |  |  |
|---|---|------------|-----|-----|----|----|---|---|
|  | Aluminio Plata <i>anodized aluminium</i> | 381.224.31 | 224 | 234 | 18 | 43 | 15 | 45 |
| | | 381.320.31 | 320 | 334 | 18 | 43 | 15 | 45 |



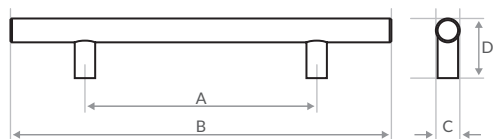

535

inox 304

Acabado finishes

Ref. model

Puerta, door

A

B

C

D



Inox
stainless steel

| | | | | | | | |
|-------------|------|------|------|----|----|---|----|
| 535. 096.57 | - | 96 | 160 | 14 | 35 | 5 | 20 |
| 535. 128.57 | - | 128 | 192 | 14 | 35 | 5 | 20 |
| 535. 160.57 | - | 160 | 224 | 14 | 35 | 5 | 20 |
| 535. 192.57 | 300 | 192 | 256 | 14 | 35 | 5 | 20 |
| 535. 242.57 | 350 | 242 | 306 | 14 | 35 | 5 | 20 |
| 535. 292.57 | 400 | 292 | 356 | 14 | 35 | 5 | 20 |
| 535. 320.57 | 450 | 320 | 384 | 14 | 35 | 5 | 20 |
| 535. 342.57 | 450 | 342 | 406 | 14 | 35 | 5 | 20 |
| 535. 392.57 | 500 | 392 | 456 | 14 | 35 | 5 | 20 |
| 535. 442.57 | 550 | 442 | 506 | 14 | 35 | 5 | 20 |
| 535. 492.57 | 600 | 492 | 556 | 14 | 35 | 5 | 20 |
| 535. 592.57 | 700 | 592 | 656 | 14 | 35 | 5 | 20 |
| 535. 692.57 | 800 | 692 | 756 | 14 | 35 | 5 | 20 |
| 535. 792.57 | 900 | 792 | 856 | 14 | 35 | 5 | 20 |
| 535.1092.57 | 1200 | 1092 | 1156 | 14 | 35 | 5 | 20 |
| 535.1192.57 | 1300 | 1192 | 1256 | 14 | 35 | 5 | 20 |
| 535.1392.57 | 1500 | 1392 | 1456 | 14 | 35 | 5 | 20 |



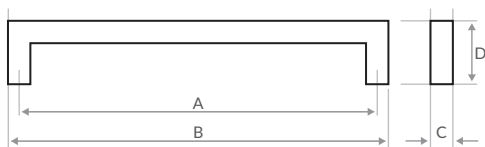

808

inox 304

Acabado finishes

Ref. model

A

B

C

D



Inox
stainless steel

808.096.57
808.128.57
808.160.57
808.192.57
808.288.57
808.392.57
808.442.57
808.492.57
808.542.57
808.692.57
808.742.57
808.992.57

96
128
160
192
288
392
442
492
542
692
742
992

108
140
172
204
300
404
454
504
554
704
754
1004

12
12
12
12
12
12
12
12
12
12
12
12

35
35
35
35
35
35
35
35
35
35
35
35

25
25
25
25
25
25
15
15
15
15
15
15

75
75
75
75
75
75
45
45
45
45
45
45

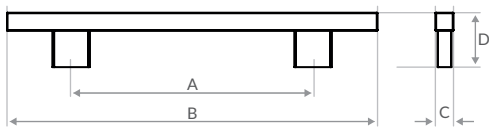

532

inox 304

Acabado finishes

Ref. model

A

B

C

D



Inox
stainless steel

532.160.57
532.224.57

160
224

244
308

12
12

36
36

20
20

60
60

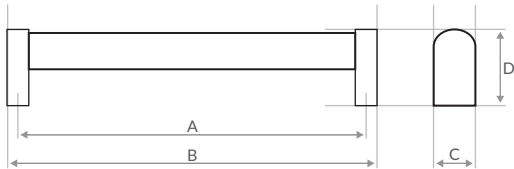

382

inox / zamak

Acabado finishes

Ref. model

A

B

C

D



Inox
stainless steel

382.192.57
382.256.57

192
256

204
268

23
23



42
42

15
15

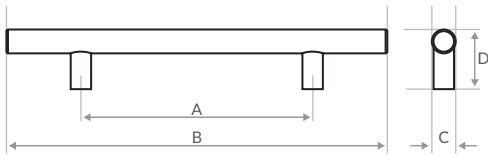
45
45



327

| acero | Acabado finishes | Ref. model | Puerta. door | A | B | C | D |  |  |
|---|-------------------------|-------------|--------------|------|------|----|----|---|---|
|  | Inox stainless steel | 327. 128.57 | - | 128 | 168 | 12 | 32 | 20 | 100 |
| | | 327. 160.57 | - | 160 | 230 | 12 | 32 | 10 | 60 |
| | | 327. 192.57 | - | 192 | 262 | 12 | 32 | 5 | 20 |
| | | 327. 224.57 | 300 | 224 | 276 | 12 | 32 | 5 | 20 |
| | | 327. 256.57 | 350 | 256 | 326 | 12 | 32 | 5 | 20 |
| | | 327. 306.57 | 400 | 306 | 376 | 12 | 32 | 5 | 20 |
| | | 327. 356.57 | 400 | 356 | 426 | 12 | 32 | 5 | 20 |
| | | 327. 430.57 | 550 | 430 | 500 | 12 | 32 | 5 | 20 |
| | | 327. 456.57 | 550 | 456 | 526 | 12 | 32 | 5 | 20 |
| | | 327. 575.57 | 700 | 575 | 645 | 12 | 32 | 5 | 20 |
| | | 327. 632.57 | 800 | 632 | 702 | 12 | 32 | 5 | 20 |
| | | 327. 758.57 | 900 | 758 | 828 | 12 | 32 | 5 | 20 |
| | | 327. 840.57 | 1000 | 840 | 910 | 12 | 32 | 5 | 20 |
| | | 327.1105.57 | 1200 | 1105 | 1175 | 12 | 32 | 5 | 20 |







**BUSCAR LA EFICIENCIA
ES UNA ACTITUD**

Una colección para los amantes de lo discreto donde el tirador y el frente encajan en perfecto equilibrio creando la fusión entre tendencia e innovación.

Tras el aspecto de sencillez de los modelos se esconden soluciones atractivas e inteligentes.

FUSION



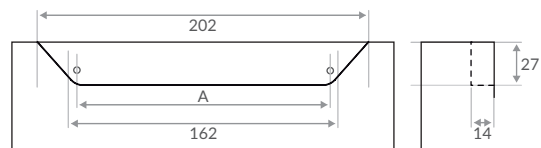
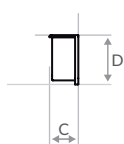
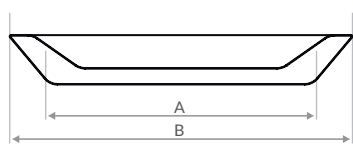

**FOLLOWING THE EFFICIENCY
IS AN ATTITUDE**

A collection for lovers of the discrete, where the handle and the furniture fit in a perfect balance, creating a fusion between trend and innovation.

In spite of the appearance of simple models, attractive and intelligent solutions are hidden.



841

| zamak | Acabado finishes | Ref. model | A | B | C | D |  |  |
|---|--|------------|-----|-----|----|----|---|---|
|  | Cromo Brillo <i>bright chrome</i> | 841.160.04 | 160 | 208 | 18 | 30 | 25 | 75 |
|  | Níquel Satinado <i>brush satin nickel</i> | 841.160.58 | 160 | 208 | 18 | 30 | 25 | 75 |

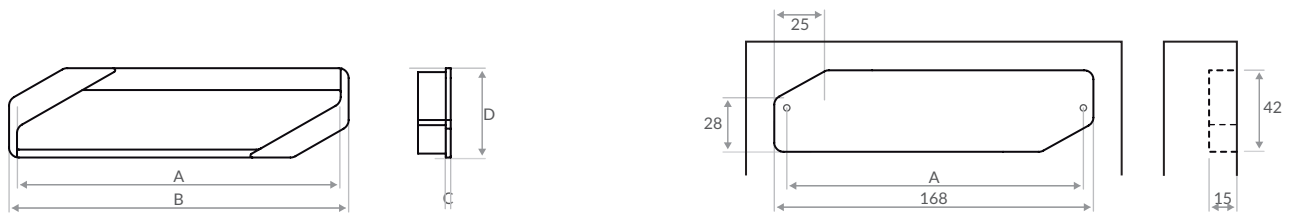

840

zamak

Acabado finishes

Ref. model

A

B

C

D



Cromo Brillo
bright chrome

840.160.04
840.160.04P

160

171

2,5

45

25

75



Níquel Satinado
brush satin nickel

840.160.58
840.160.58P

160

171

2,5

45



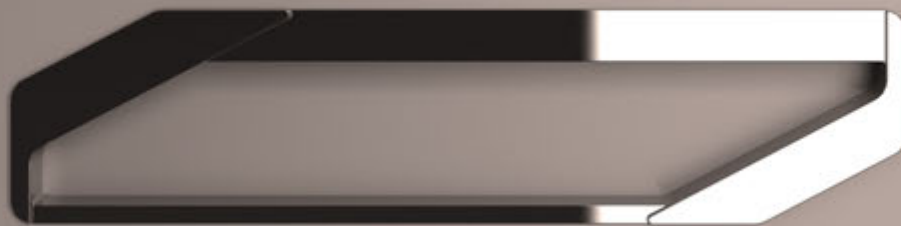

25

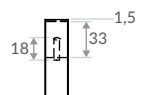
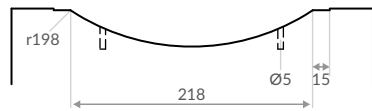
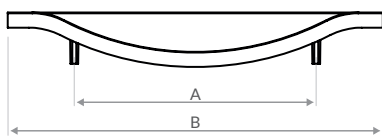
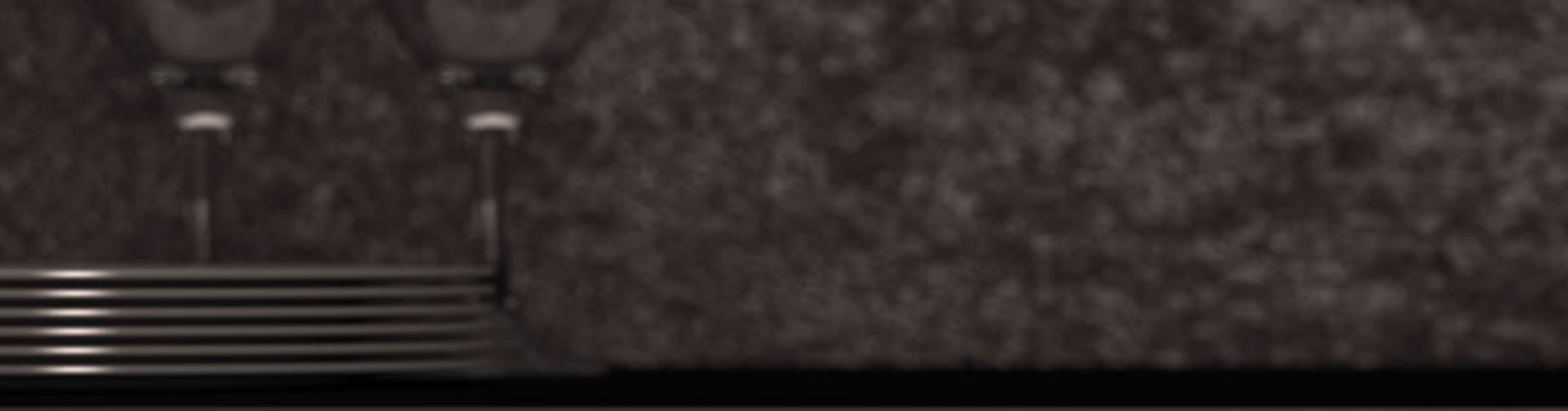
75







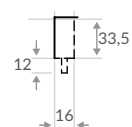
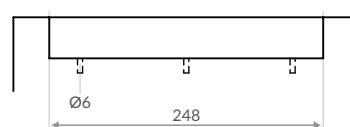
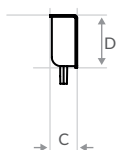
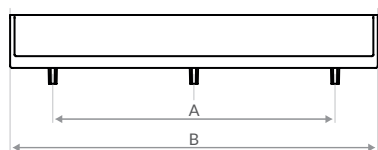

831

| zamak | Acabado finishes | Ref. model | A | B | C | c | D |  |  |
|---|--|------------|-----|-----|------|-----|----|---|---|
|  | Cromo Brillo <i>bright chrome</i> | 831.250.04 | 160 | 248 | 20,5 | 1,5 | 36 | 25 | 75 |
|  | Níquel Satinado <i>brush satin nickel</i> | 831.250.58 | 160 | 248 | 20,5 | 1,5 | 36 | 25 | 75 |





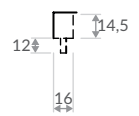
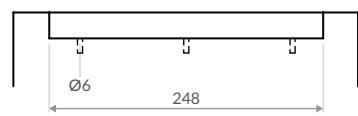
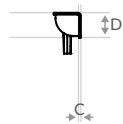
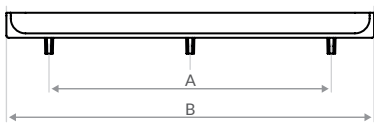

827

| zamak | Acabado finishes | Ref. model | A | B | C | D |  |  |
|--|--------------------------------------|------------|-----|----|----|---|---|---|
|  | Cromo Brillo <i>bright chrome</i> | 827.250.04 | 250 | 19 | 36 | | 25 | 75 |
|  | Níquel Mate <i>mat nickel</i> | 827.250.59 | 250 | 19 | 36 | | 25 | 75 |









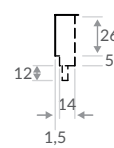
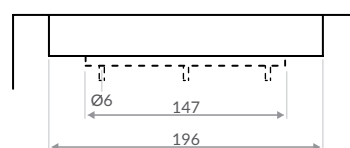
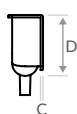
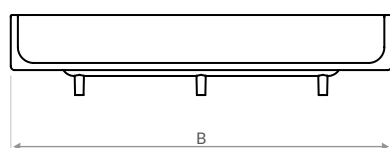

826

| zamak | Acabado finishes | Ref. model | A | B | C | D |  |  |
|---|--------------------------------------|------------|--------|-----|----|----|---|---|
|  | Cromo Brillo <i>bright chrome</i> | 826.250.04 | 96-192 | 250 | 19 | 17 | 25 | 75 |
|  | Níquel Mate <i>mat nickel</i> | 826.250.59 | 96-192 | 250 | 19 | 17 | 25 | 75 |

*tirador oculto





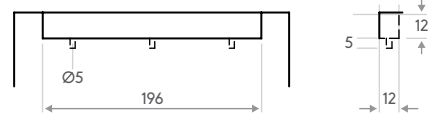
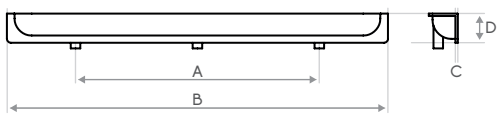

820

| zamak | Acabado finishes | Ref. model | A | B | C | D |  |  |
|---|--------------------------------------|------------|---|-----|------|----|---|---|
|  | Cromo Brillo <i>bright chrome</i> | 820.200.04 | | 200 | 1,25 | 28 | 25 | 75 |
|  | Cromo Mate <i>mat chrome</i> | 820.200.30 | | 200 | 1,25 | 28 | 25 | 75 |
|  | Níquel Mate <i>mat nickel</i> | 820.200.59 | | 200 | 1,25 | 28 | 25 | 75 |





819

| zamak | Acabado finishes | Ref. model | A | B | C | D |  |  |
|---|---|------------|--------|-----|------|----|---|---|
|  | Cromo Brillo <i>bright chrome</i> | 819.200.04 | 64-128 | 200 | 1,25 | 15 | 25 | 75 |
|  | Cromo Mate <i>mat chrome</i> | 819.200.30 | 64-128 | 200 | 1,25 | 15 | 25 | 75 |
|  | Níquel Mate <i>mat nickel</i> | 819.200.59 | 64-128 | 200 | 1,25 | 15 | 25 | 75 |

*tirador oculto

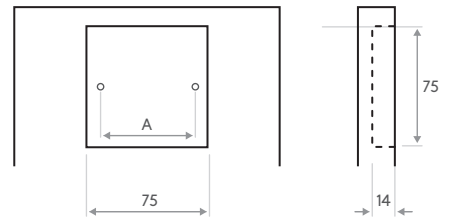
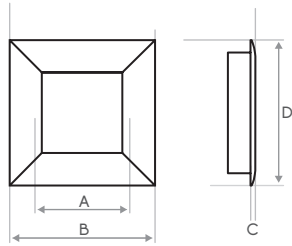

812

zamak

Acabado finishes

Ref. model

A

B

C

D



Cromo Brillo
bright chrome

812.064.04

64

90

3

90

15

45



Cromo Mate
mat chrome

812.064.30

64

90

3

90

15

45



Níquel Satinado
brush satin nickel

812.064.58

64

90

3

90





15

45







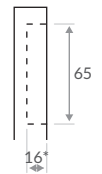
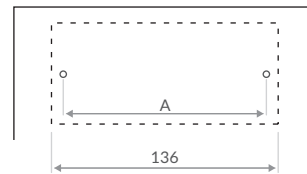
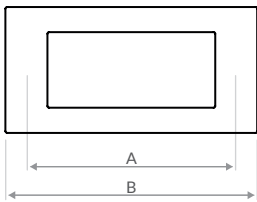

811

| zamak | Acabado finishes | Ref. model | A | B | C | D |  |  |
|---|-------------------------------|------------|-----|-----|---|----|---|---|
|  | Cromo Brillo bright chrome | 811.160.04 | 160 | 200 | 2 | 50 | 25 | 75 |
|  | Cromo Look look chrome | 811.160.63 | 160 | 200 | 2 | 50 | 25 | 75 |



*con tapa trasera
+ 2mm



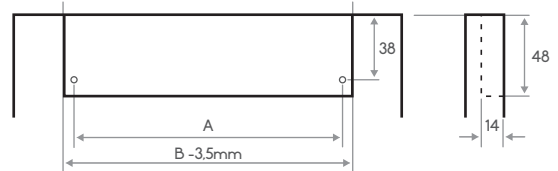
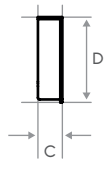
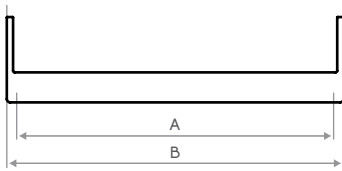

810

| zamak | Acabado finishes | Ref. model | A | B | C | D |  |  |
|---|---|------------|-----|-----|---|----|---|---|
|  | Cromo Brillo <i>bright chrome</i> | 810.128.04 | 128 | 150 | 3 | 75 | 25 | 75 |
|  | Cromo Mate <i>mat chrome</i> | 810.128.30 | 128 | 150 | 3 | 75 | 25 | 75 |
|  | Níquel Satinado <i>brush satin nickel</i> | 810.128.58 | 128 | 150 | 3 | 75 | 25 | 75 |





582

| zamak | Acabado finishes | Ref. model | A | B | C | D |  |  |
|---|---------------------------------------|------------|-----|-----|----|----|---|---|
|  | Cromo Brillo bright chrome | 582.096.04 | 96 | 106 | 15 | 51 | 25 | 75 |
| | | 582.192.04 | 192 | 202 | 15 | 51 | 25 | 100 |
|  | Níquel Satinado brush satin nickel | 582.096.58 | 96 | 106 | 15 | 51 | 25 | 75 |
| | | 582.192.58 | 192 | 202 | 15 | 51 | 25 | 100 |

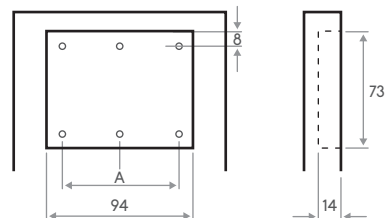
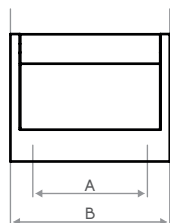

379

zamak

Acabado finishes

Ref. model

A

B

C

D



Cromo Brillo
bright chrome

379.064.04

32-64

100

2

80

10

30



Cromo Mate
mat chrome

379.064.30

32-64

100

2

80

10

30



Níquel Satinado
brush satin nickel

379.064.58

32-64

100

2

80

10

30

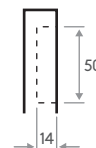
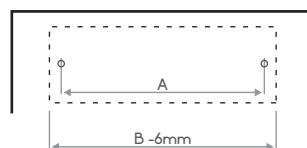
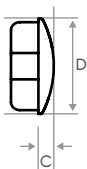
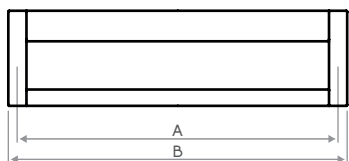

353

aluminio/zamak

Acabado finishes

Ref. model

A

B

C

D



Aluminio Plata
anodized silver

353Z.160.31

160

172

8

54

25

75

355Z.192.31

192

204

8

54

25

75

353Z.3000.31

Perfil 3mtrs. / Profile 3mtrs.

10

-

353Z.31

Laterales Zamak Mate / Ends Mat Zamak50

-

-

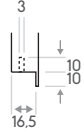
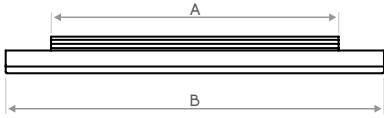

767

aluminio

Acabado finishes

Ref. model

A

B

C

D



Plata Satinada
brush satin silver

| |
|-------------|
| 767. 400.32 |
| 767. 450.32 |
| 767. 500.32 |
| 767. 600.32 |
| 767. 700.32 |
| 767. 800.32 |
| 767. 900.32 |
| 767.1000.32 |
| 767.1200.32 |

| | | | |
|------|------|----|----|
| 340 | 398 | 18 | ?? |
| 390 | 448 | 18 | ?? |
| 440 | 498 | 18 | ?? |
| 540 | 598 | 18 | ?? |
| 640 | 698 | 18 | ?? |
| 740 | 798 | 18 | ?? |
| 840 | 898 | 18 | ?? |
| 940 | 998 | 18 | ?? |
| 1140 | 1198 | 18 | ?? |

| | |
|----|----|
| 20 | 60 |
| 20 | 60 |
| 20 | 60 |
| 20 | 60 |
| 20 | 60 |
| 20 | 60 |
| 20 | 60 |
| 20 | 60 |
| 20 | 60 |

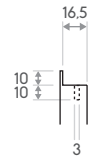
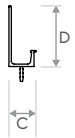
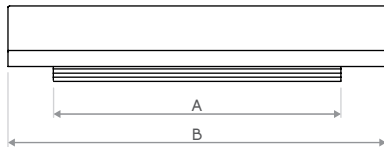
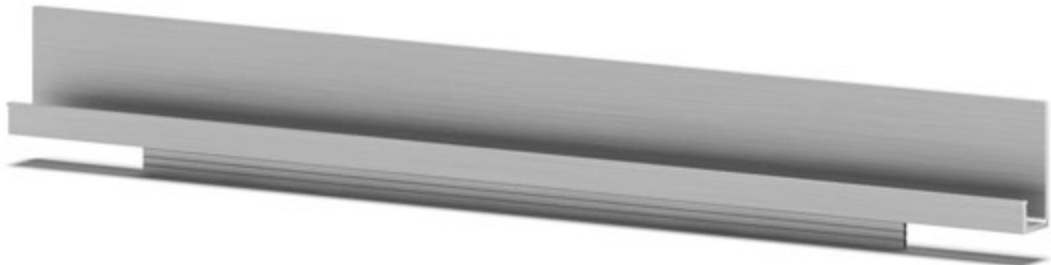

766

aluminio

Acabado finishes

Ref. model

A

B

C

D



Plata Satinada
brush satin silver

| |
|-------------|
| 766. 150.32 |
| 766. 200.32 |
| 766. 250.32 |
| 766. 300.32 |
| 766. 350.32 |
| 766. 400.32 |
| 766. 450.32 |
| 766. 500.32 |
| 766. 600.32 |
| 766. 700.32 |
| 766. 800.32 |
| 766. 900.32 |
| 766.1000.32 |
| 766.1200.32 |

| | | | |
|------|------|----|----|
| 90 | 148 | 18 | 40 |
| 140 | 198 | 18 | 40 |
| 190 | 248 | 18 | 40 |
| 240 | 298 | 18 | 40 |
| 290 | 348 | 18 | 40 |
| 340 | 398 | 18 | 40 |
| 390 | 448 | 18 | 40 |
| 440 | 498 | 18 | 40 |
| 540 | 598 | 18 | 40 |
| 640 | 698 | 18 | 40 |
| 740 | 798 | 18 | 40 |
| 840 | 898 | 18 | 40 |
| 940 | 998 | 18 | 40 |
| 1140 | 1198 | 18 | 40 |

| | |
|----|----|
| 20 | 60 |
| 20 | 60 |
| 20 | 60 |
| 20 | 60 |
| 20 | 60 |
| 20 | 60 |
| 20 | 60 |
| 20 | 60 |
| 20 | 60 |
| 20 | 60 |
| 20 | 60 |
| 20 | 60 |
| 20 | 60 |
| 20 | 60 |

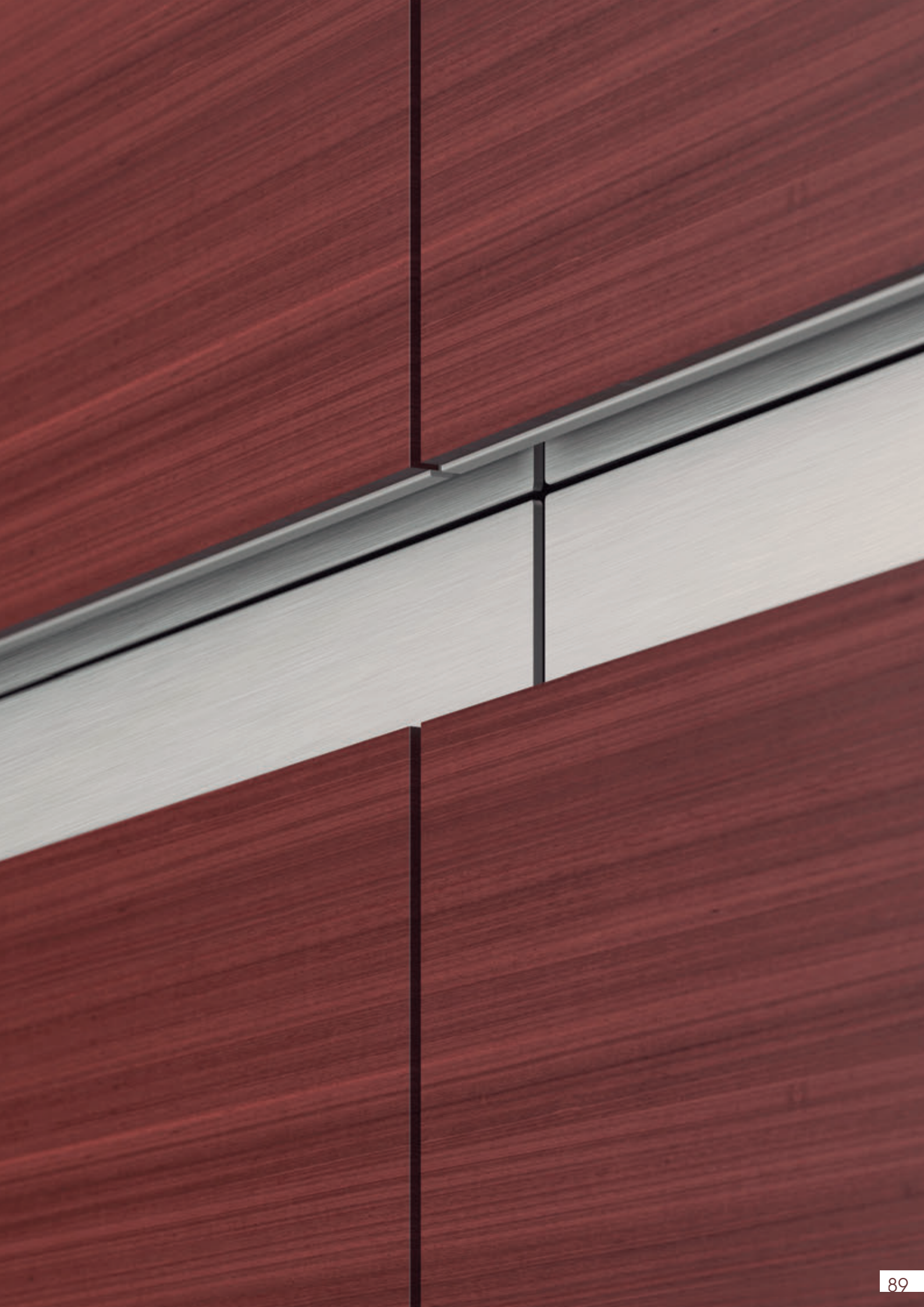

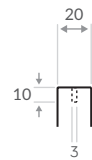
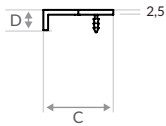
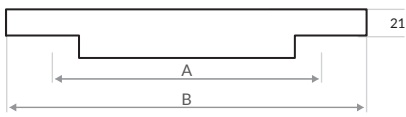

765

aluminio Acabado finishes

Ref. model

A

B

C

D



Plata Satinada
brush satin silver

| | | | | | | |
|-------------|------|------|----|----|----|----|
| 765. 150.32 | 90 | 148 | 39 | 11 | 20 | 60 |
| 765. 200.32 | 140 | 198 | 39 | 11 | 20 | 60 |
| 765. 250.32 | 190 | 248 | 39 | 11 | 20 | 60 |
| 765. 300.32 | 240 | 298 | 39 | 11 | 20 | 60 |
| 765. 350.32 | 290 | 348 | 39 | 11 | 20 | 60 |
| 765. 400.32 | 340 | 398 | 39 | 11 | 20 | 60 |
| 765. 450.32 | 390 | 448 | 39 | 11 | 20 | 60 |
| 765. 500.32 | 440 | 498 | 39 | 11 | 20 | 60 |
| 765. 600.32 | 540 | 598 | 39 | 11 | 20 | 60 |
| 765. 700.32 | 640 | 698 | 39 | 11 | 20 | 60 |
| 765. 800.32 | 740 | 798 | 39 | 11 | 20 | 60 |
| 765. 900.32 | 840 | 898 | 39 | 11 | 20 | 60 |
| 765.1000.32 | 940 | 998 | 39 | 11 | 20 | 60 |
| 765.1200.32 | 1140 | 1198 | 39 | 11 | 20 | 60 |

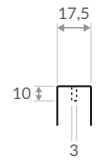
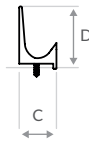
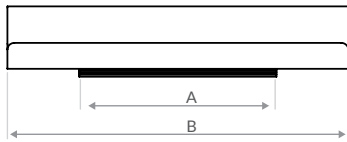

355

aluminio

Acabado finishes

Ref. model

A

B

C

D



Aluminio Plata
anodized silver

| | | | | |
|-------------|------|------|----|----|
| 355. 250.31 | 190 | 248 | 19 | 25 |
| 355. 300.31 | 240 | 298 | 19 | 25 |
| 355. 350.31 | 290 | 348 | 19 | 25 |
| 355. 400.31 | 340 | 398 | 19 | 25 |
| 355. 450.31 | 390 | 448 | 19 | 25 |
| 355. 500.31 | 440 | 498 | 19 | 25 |
| 355. 600.31 | 540 | 598 | 19 | 25 |
| 355. 700.31 | 640 | 698 | 19 | 25 |
| 355. 800.31 | 740 | 798 | 19 | 25 |
| 355. 900.31 | 840 | 898 | 19 | 25 |
| 355.1000.31 | 940 | 998 | 19 | 25 |
| 355.1200.31 | 1140 | 1198 | 19 | 25 |

| | |
|----|----|
| 15 | 45 |
| 15 | 45 |
| 15 | 45 |
| 15 | 45 |
| 15 | 45 |
| 15 | 45 |
| 15 | 45 |
| 15 | 45 |
| 15 | 45 |
| 15 | 45 |
| 15 | 45 |
| 15 | 45 |

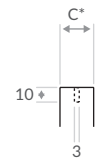
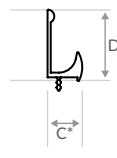
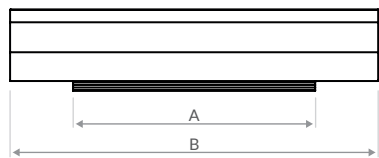

352

aluminio

Acabado finishes

Ref. model

A

B

C

D



Aluminio Plata
anodized silver

disponible puerta 19/21

| | | | | |
|-------------|------|------|-------|----|
| 352. 250.31 | 190 | 248 | 19/21 | 43 |
| 352. 300.31 | 240 | 298 | 19/21 | 43 |
| 352. 350.31 | 290 | 348 | 19/21 | 43 |
| 352. 400.31 | 340 | 398 | 19/21 | 43 |
| 352. 450.31 | 390 | 448 | 19/21 | 43 |
| 352. 500.31 | 440 | 498 | 19/21 | 43 |
| 352. 600.31 | 540 | 598 | 19/21 | 43 |
| 352. 700.31 | 640 | 698 | 19/21 | 43 |
| 352. 800.31 | 740 | 798 | 19/21 | 43 |
| 352. 900.31 | 840 | 898 | 19/21 | 43 |
| 352.1200.31 | 1140 | 1198 | 19/21 | 43 |

| | |
|----|----|
| 10 | 30 |
| 10 | 30 |
| 10 | 30 |
| 10 | 30 |
| 10 | 30 |
| 10 | 30 |
| 10 | 30 |
| 10 | 30 |
| 10 | 30 |
| 10 | 30 |
| 10 | 30 |
| 10 | 30 |

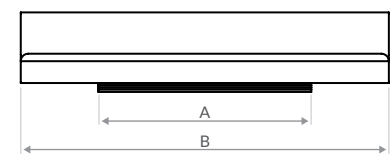

351

aluminio

Acabado finishes

Ref. model

A

B

C

D





Aluminio Plata
anodized silver

| | | | | |
|-------------|------|------|----|----|
| 351. 250.31 | 190 | 248 | 19 | 25 |
| 351. 300.31 | 240 | 298 | 19 | 25 |
| 351. 350.31 | 290 | 348 | 19 | 25 |
| 351. 400.31 | 340 | 398 | 19 | 25 |
| 351. 450.31 | 390 | 448 | 19 | 25 |
| 351. 500.31 | 440 | 498 | 19 | 25 |
| 351. 600.31 | 540 | 598 | 19 | 25 |
| 351. 700.31 | 640 | 698 | 19 | 25 |
| 351. 800.31 | 740 | 798 | 19 | 25 |
| 351. 900.31 | 840 | 898 | 19 | 25 |
| 351.1200.31 | 1140 | 1198 | 19 | 25 |

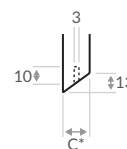
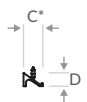
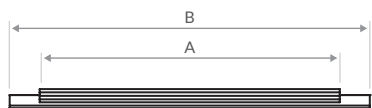
| | |
|----|----|
| 15 | 45 |
| 15 | 45 |
| 15 | 45 |
| 15 | 45 |
| 15 | 45 |
| 15 | 45 |
| 15 | 45 |
| 15 | 45 |
| 15 | 45 |
| 15 | 45 |
| 15 | 45 |
| 15 | 45 |



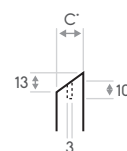
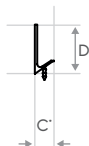
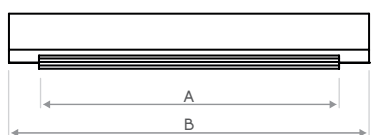

762

| aluminio | Acabado finishes | Ref. model | A | B | C | D |  |  |
|---|-------------------------------|-------------|------|------|----|----|---|---|
|  | Plata Mate anodized silver | 762. 150.31 | 90 | 150 | 19 | 15 | 20 | 60 |
| | | 762. 250.31 | 190 | 250 | 19 | 15 | 20 | 60 |
| | | 762. 300.31 | 240 | 300 | 19 | 15 | 20 | 60 |
| | | 762. 350.31 | 290 | 350 | 19 | 15 | 20 | 60 |
| | | 762. 400.31 | 340 | 400 | 19 | 15 | 20 | 60 |
| | | 762. 450.31 | 390 | 450 | 19 | 15 | 20 | 60 |
| | | 762. 500.31 | 440 | 500 | 19 | 15 | 20 | 60 |
| | | 762. 600.31 | 540 | 600 | 19 | 15 | 20 | 60 |
| | | 762. 700.31 | 640 | 700 | 19 | 15 | 20 | 60 |
| | | 762. 800.31 | 740 | 800 | 19 | 15 | 20 | 60 |
| | | 762. 900.31 | 840 | 900 | 19 | 15 | 20 | 60 |
| | | 762.1000.31 | 940 | 1000 | 19 | 15 | 20 | 60 |
| | | 762.1200.31 | 1140 | 1200 | 19 | 15 | 20 | 60 |





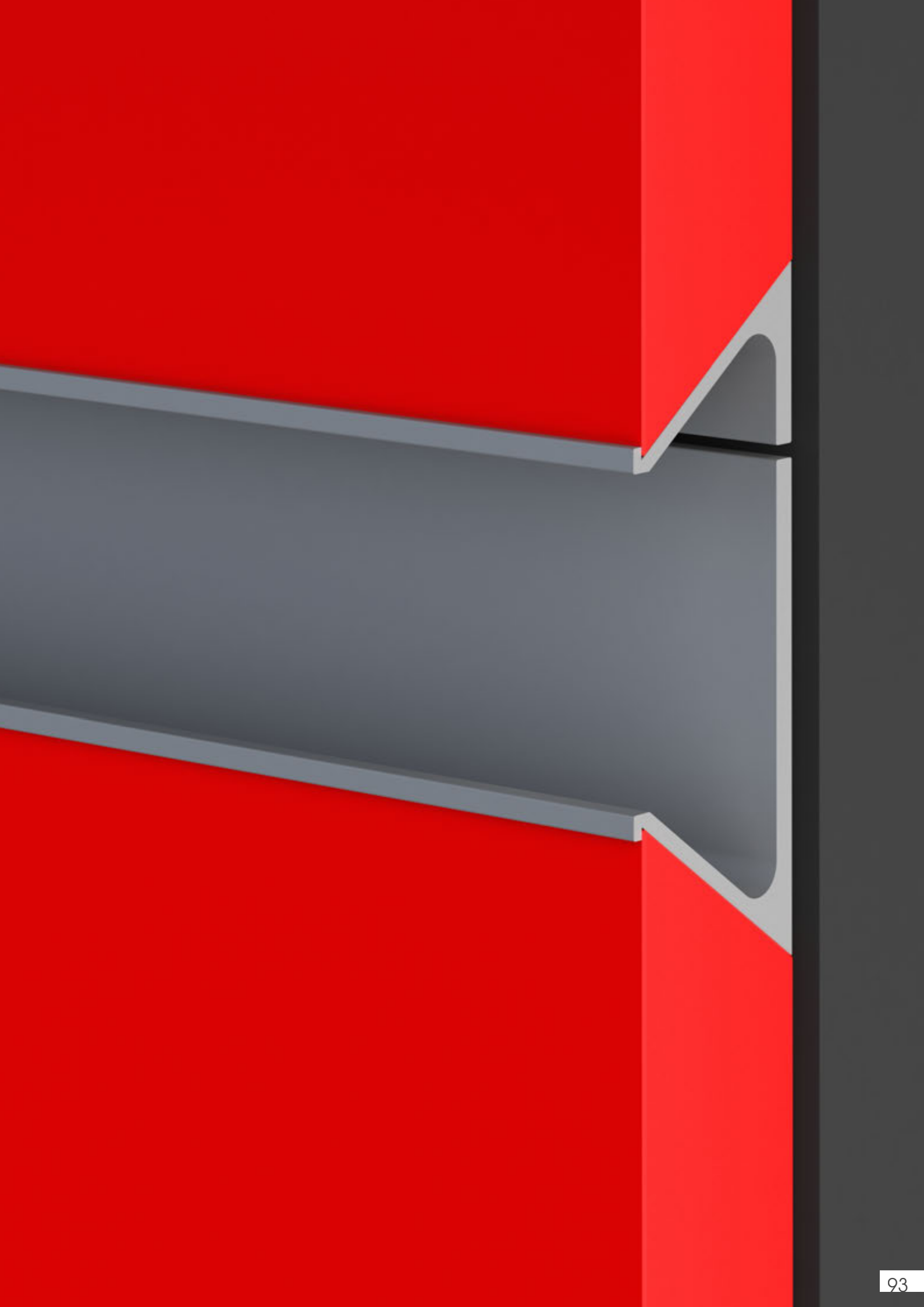

761

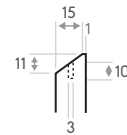
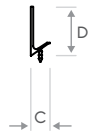
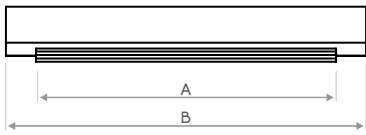
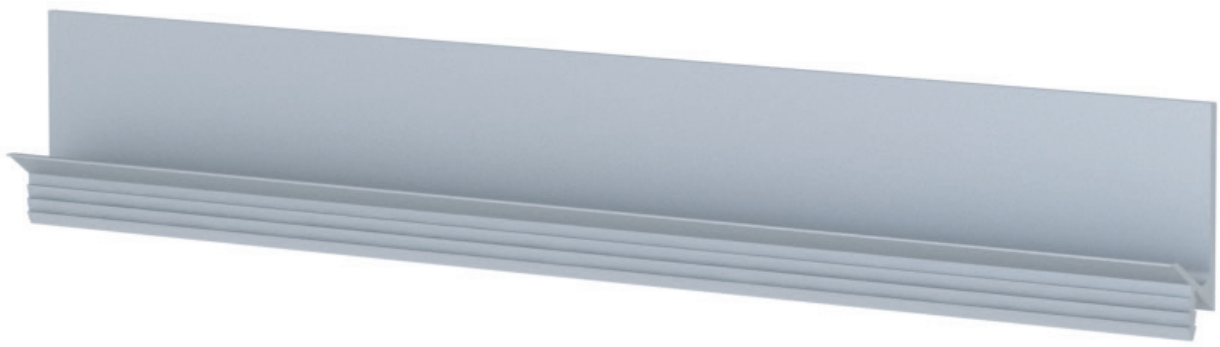
| aluminio | Acabado finishes | Ref. model | A | B | C | D |  |  |
|---|-------------------------------|-------------|------|------|----|----|---|---|
|  | Plata Mate anodized silver | 761. 150.31 | 90 | 150 | 19 | 42 | 20 | 60 |
| | | 761. 250.31 | 190 | 250 | 19 | 42 | 20 | 60 |
| | | 761. 300.31 | 240 | 300 | 19 | 42 | 20 | 60 |
| | | 761. 350.31 | 290 | 350 | 19 | 42 | 20 | 60 |
| | | 761. 400.31 | 340 | 400 | 19 | 42 | 20 | 60 |
| | | 761. 450.31 | 390 | 450 | 19 | 42 | 20 | 60 |
| | | 761. 500.31 | 440 | 500 | 19 | 42 | 20 | 60 |
| | | 761. 600.31 | 540 | 600 | 19 | 42 | 20 | 60 |
| | | 761. 700.31 | 640 | 700 | 19 | 42 | 20 | 60 |
| | | 761. 800.31 | 740 | 800 | 19 | 42 | 20 | 60 |
| | | 761. 900.31 | 840 | 900 | 19 | 42 | 20 | 60 |
| | | 761.1000.31 | 940 | 1000 | 19 | 42 | 20 | 60 |
| | | 761.1200.31 | 1140 | 1200 | 19 | 42 | 20 | 60 |





760

| aluminio | Acabado finishes | Ref. model | A | B | C | D |  |  |
|---|--|-------------|-----|------|----|----|---|---|
|  | Plata Brillo <i>silver gloss</i> | 760. 600.29 | 540 | 600 | 16 | 45 | 20 | 60 |
| | | 760. 700.29 | 640 | 700 | 16 | 45 | 20 | 60 |
| | | 760. 800.29 | 740 | 800 | 16 | 45 | 20 | 60 |
| | | 760.1000.29 | 940 | 1000 | 16 | 45 | 20 | 60 |
|  | Plata Mate <i>anodized silver</i> | 760. 150.31 | 90 | 150 | 16 | 45 | 20 | 60 |
| | | 760. 250.31 | 190 | 250 | 16 | 45 | 20 | 60 |
| | | 760. 300.31 | 240 | 300 | 16 | 45 | 20 | 60 |
| | | 760. 350.31 | 290 | 350 | 16 | 45 | 20 | 60 |
| | | 760. 400.31 | 340 | 400 | 16 | 45 | 20 | 60 |
| | | 760. 450.31 | 390 | 450 | 16 | 45 | 20 | 60 |
| | | 760. 500.31 | 440 | 500 | 16 | 45 | 20 | 60 |
| | | 760. 600.31 | 540 | 600 | 16 | 45 | 20 | 60 |
| | | 760. 700.31 | 640 | 700 | 16 | 45 | 20 | 60 |
| | | 760. 800.31 | 740 | 800 | 16 | 45 | 20 | 60 |
| | | 760. 900.31 | 840 | 900 | 16 | 45 | 20 | 60 |
| | | 760.1000.31 | 940 | 1000 | 16 | 45 | 20 | 60 |
| 760.1200.31 | 1140 | 1200 | 16 | 45 | 20 | 60 | | |
|  | Anodizado níquel <i>mat nickel anodized</i> | 760. 150.59 | 90 | 150 | 16 | 45 | 20 | 60 |
| | | 760. 250.59 | 190 | 250 | 16 | 45 | 20 | 60 |
| | | 760. 300.59 | 240 | 300 | 16 | 45 | 20 | 60 |
| | | 760. 350.59 | 290 | 350 | 16 | 45 | 20 | 60 |
| | | 760. 400.59 | 340 | 400 | 16 | 45 | 20 | 60 |
| | | 760. 450.59 | 390 | 450 | 16 | 45 | 20 | 60 |
| | | 760. 500.59 | 440 | 500 | 16 | 45 | 20 | 60 |
| | | 760. 600.59 | 540 | 600 | 16 | 45 | 20 | 60 |
| | | 760. 700.59 | 640 | 700 | 16 | 45 | 20 | 60 |
| | | 760. 800.59 | 740 | 800 | 16 | 45 | 20 | 60 |
| | | 760. 900.59 | 840 | 900 | 16 | 45 | 20 | 60 |
| | | 760.1000.59 | 940 | 1000 | 16 | 45 | 20 | 60 |
| 760.1200.59 | 1140 | 1200 | 16 | 45 | 20 | 60 | | |

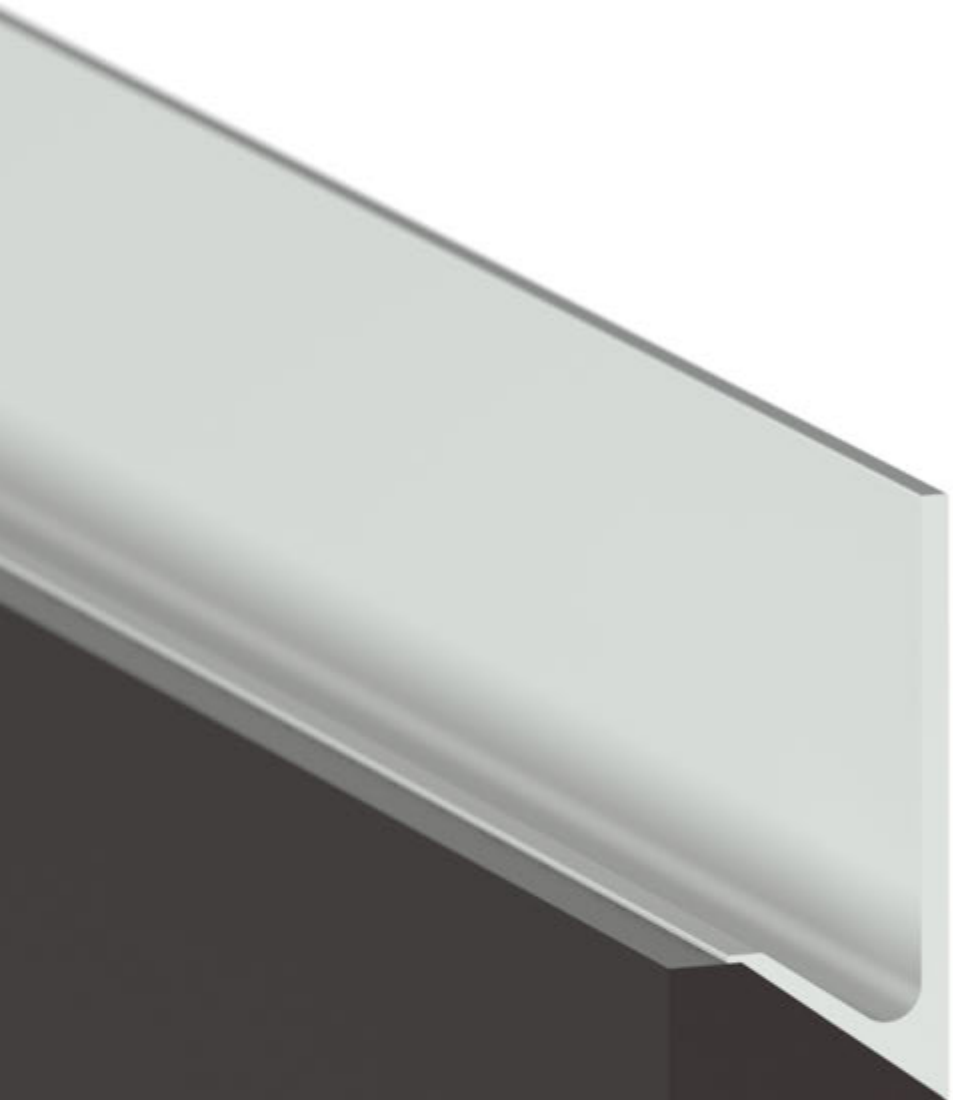

simple solutions

An abstract 3D composition featuring a prominent blue horizontal bar at the top. Below it, several light grey rectangular blocks are arranged in a staggered, overlapping fashion. In the background, a series of dark blue, semi-transparent circular rings are visible, creating a sense of depth and movement. The overall aesthetic is clean, modern, and architectural.

DALE **LUZ** A TUS IDEAS

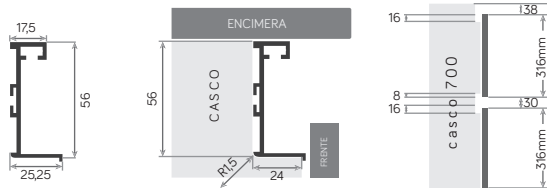
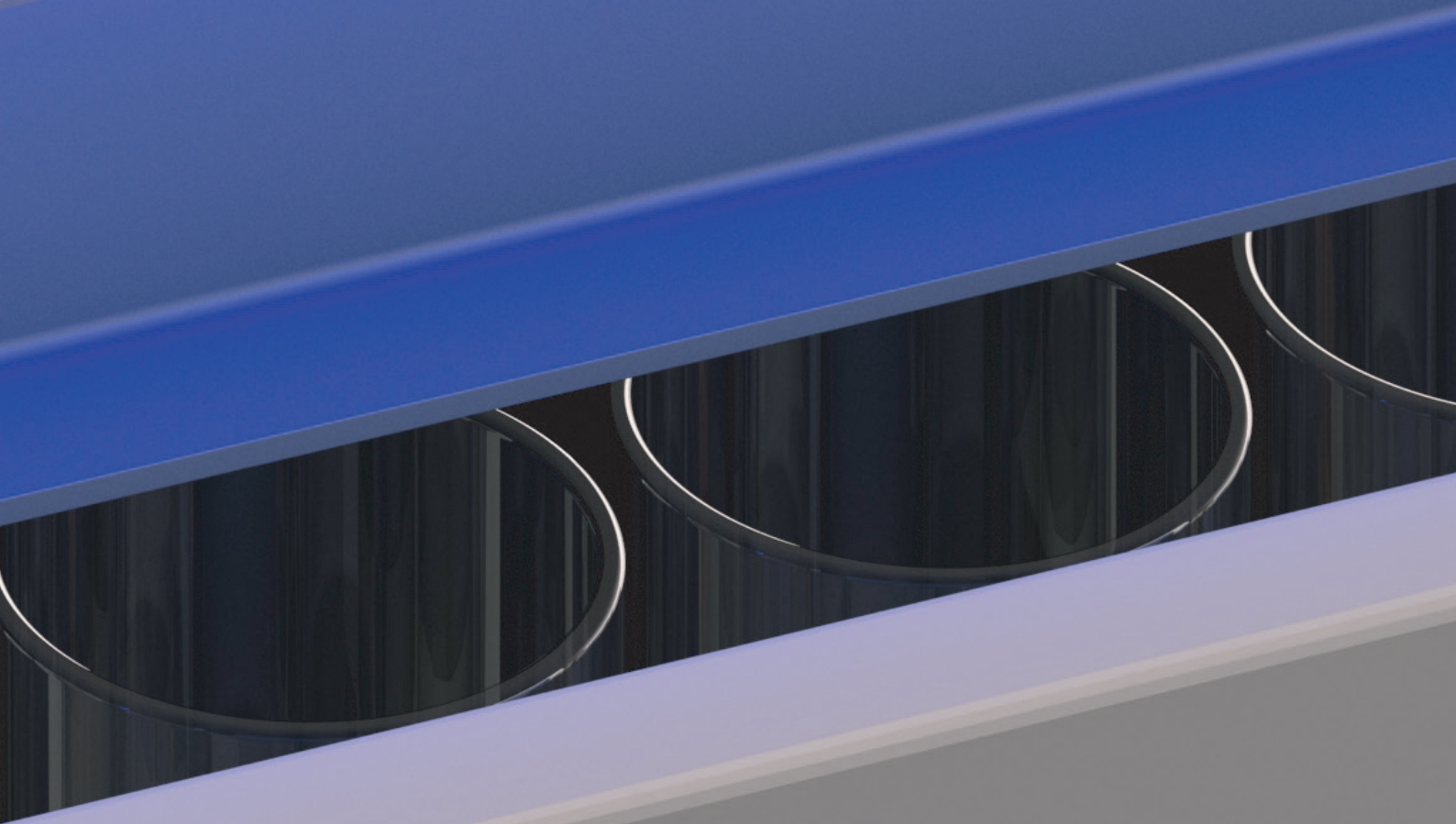

750

| aluminio | Acabado finishes | Ref. model | mm. | | |
|----------|---|-------------|-----------|---|--|
| | Plata mate / <i>anodized silver</i> | 750.4000.31 | 4,0 mtrs. | 6 | |
| | Lacado blanco / <i>white</i> | 750.4000.06 | 4,0 mtrs. | 6 | |
| | Plata brillo / <i>gloss silver</i> | 750.4000.29 | 4,0 mtrs. | 6 | |
| | Anodizado negro / <i>black</i> | 750.4000.51 | 4,0 mtrs. | 6 | |
| | Anodizado níquel / <i>anodized nickel</i> | 750.4000.59 | 4,0 mtrs. | 6 | |



ACCESORIOS

LATERAL IZQUIERDO



| ref. | descripción | uds. |
|---------|--------------|------|
| 750.06i | Blanco | 12 |
| 750.31i | Plata mate | 12 |
| 750.51i | Negro brillo | 12 |
| 750.59i | Níquel | 12 |

LATERAL DERECHO



| ref. | descripción | uds. |
|---------|--------------|------|
| 750.06d | Blanco | 12 |
| 750.31d | Plata mate | 12 |
| 750.51d | Negro brillo | 12 |
| 750.59d | Níquel | 12 |

RINCÓN 90°



| ref. | descripción | uds. |
|---------|--------------|------|
| 750.06r | Blanco | 12 |
| 750.31r | Plata mate | 12 |
| 750.51r | Negro brillo | 12 |
| 750.59r | Níquel | 12 |

ESQUINA 90°



| ref. | descripción | uds. |
|---------|--------------|------|
| 750.06e | Blanco | 12 |
| 750.31e | Plata mate | 12 |
| 750.51e | Negro brillo | 12 |
| 750.59e | Níquel | 12 |

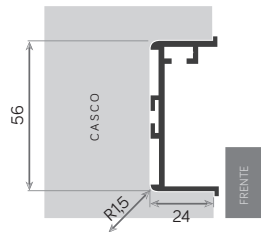
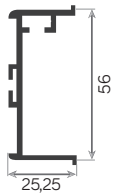

751

| aluminio | Acabado finishes | Ref. model | mm. | |
|----------|------------------------------------|-------------|-----------|---|
| | Plata mate / anodized silver | 751.4000.31 | 4,0 mtrs. | 6 |
| | Lacado blanco / white | 751.4000.06 | 4,0 mtrs. | 6 |
| | Plata brillo / gloss silver | 751.4000.29 | 4,0 mtrs. | 6 |
| | Anodizado negro / black | 751.4000.51 | 4,0 mtrs. | 6 |
| | Anodizado níquel / anodized nickel | 751.4000.59 | 4,0 mtrs. | 6 |

ACCESORIOS

LATERAL IZQUIERDO



| ref. | descripción | uds. |
|---------|--------------|------|
| 751.06i | Blanco | 12 |
| 751.31i | Plata mate | 12 |
| 751.51i | Negro brillo | 12 |
| 751.59i | Níquel | 12 |

LATERAL DERECHO



| ref. | descripción | uds. |
|---------|--------------|------|
| 751.06d | Blanco | 12 |
| 751.31d | Plata mate | 12 |
| 751.51d | Negro brillo | 12 |
| 751.59d | Níquel | 12 |

RINCÓN 90°



| ref. | descripción | uds. |
|---------|--------------|------|
| 750.06r | Blanco | 12 |
| 750.31r | Plata mate | 12 |
| 750.51r | Negro brillo | 12 |
| 750.59r | Níquel | 12 |

ESQUINA 90°



| ref. | descripción | uds. |
|---------|--------------|------|
| 750.06e | Blanco | 12 |
| 750.31e | Plata mate | 12 |
| 750.51e | Negro brillo | 12 |
| 750.59e | Níquel | 12 |

ACCESORIOS

ESCUADRA J - U



| ref. | descripción | uds. |
|--------|-------------|------|
| 758.29 | Zinc plata | 25 |

GRAPA ESTRIADA J - U



| ref. | descripción | uds. |
|--------|-------------|------|
| 759.51 | Nylon negro | 25 |

KIT DE ALIMENTACIÓN



| ref. | descripción |
|---------|-------------|
| 741.18W | 18W |
| 741.30W | 30W |

TIRA DE LED FLEXIBLE



| ref. | descripción | mtrs. |
|-------------|---------------|--------|
| L107.200.06 | Blanco frío | 2mtrs. |
| L107.300.06 | Blanco frío | 3mtrs. |
| L107.300.07 | Blanco cálido | 3mtrs. |
| L107.300.10 | Azul | 3mtrs. |
| L107.500.06 | Blanco frío | 5mtrs. |
| L107.500.07 | Blanco cálido | 5mtrs. |
| L107.500.10 | Azul | 5mtrs. |

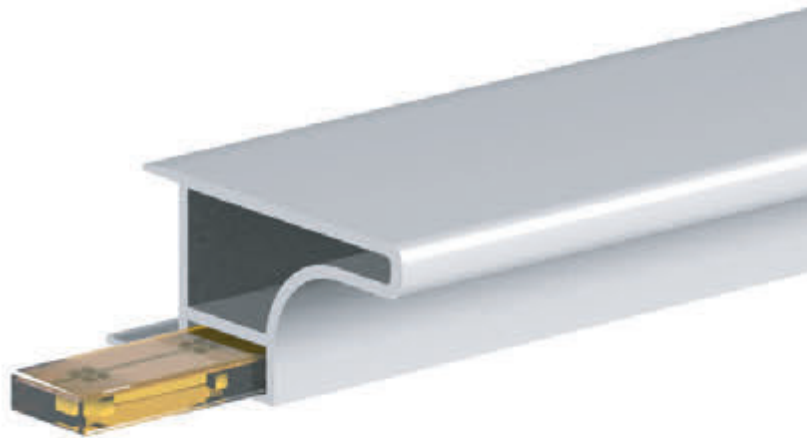
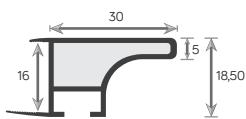

752

aluminio

Acabado finishes

Ref. model

mm.



Plata mate / anodized silver

752.4000.31

4,0 mtrs.

10

Medidas perfil



Cajeado casco

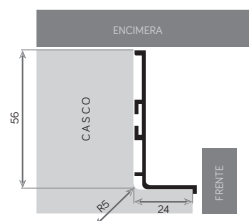

Medidas cajones

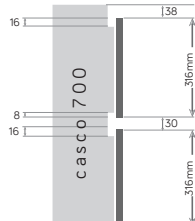

753 J SUPERIOR

aluminio Acabado finishes Ref. model mm.

| | | | | |
|--|-------------------------------|-------------|-----------|----|
| | Plata mate / bright chrome | 753.4000.31 | 4,0 mtrs. | 10 |
| | Lacado blanco / bright chrome | 753.4000.06 | 4,0 mtrs. | 10 |

LATERAL IZQUIERDO



| ref. | descripción | uds. |
|---------|-------------|------|
| 753.06i | Blanco | 12 |
| 753.31i | Plata mate | 12 |

LATERAL DERECHO



| ref. | descripción | uds. |
|---------|-------------|------|
| 753.06d | Blanco | 12 |
| 753.31d | Plata mate | 12 |

Cajeado casco

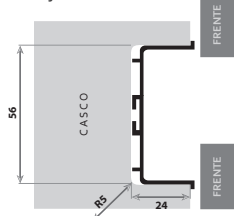

754 U CENTRAL

aluminio Acabado finishes Ref. model mm.

| | | | | |
|--|------------------------------|-------------|-----------|----|
| | Blanco / white | 754.4000.06 | 4,0 mtrs. | 10 |
| | Plata mate / anodized silver | 754.4000.31 | 4,0 mtrs. | 10 |

LATERAL IZQ. / DCH.



| ref. | descripción | uds. |
|--------|-------------|------|
| 754.06 | Blanco | 12 |
| 754.31 | Plata mate | 12 |



ESCUADRA SUJECCIÓN

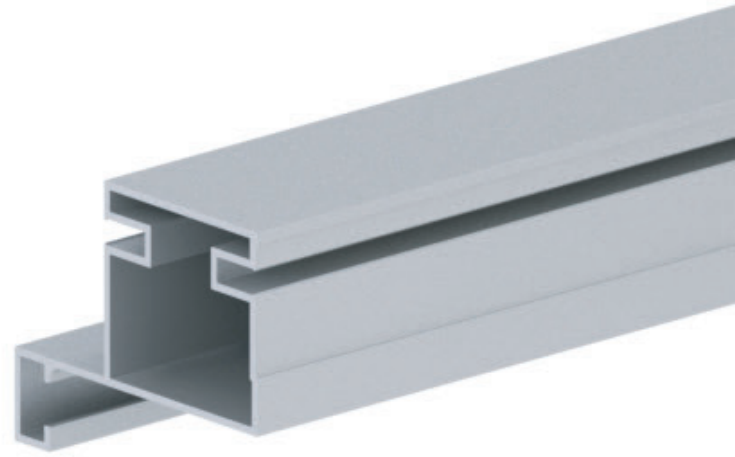

| ref. | descripción | uds. |
|--------|-------------|------|
| 758.29 | Zinc plata | 25 |



755 V1 LATERAL

| aluminio | Acabado finishes | Ref. model | mm. |  |
|---|------------------------------|--------------|-----------|---|
|  | Plata mate / anodized silver | 755.2400.31 | 2,4 mtrs. | 6 |
|  | Lacado blanco / white | 755.2400.06 | 2,4 mtrs. | 6 |
| | Perfil LED PVC | 755.2400.PVC | 2,4 mtrs. | 12 |

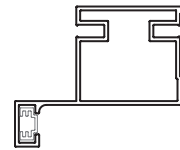

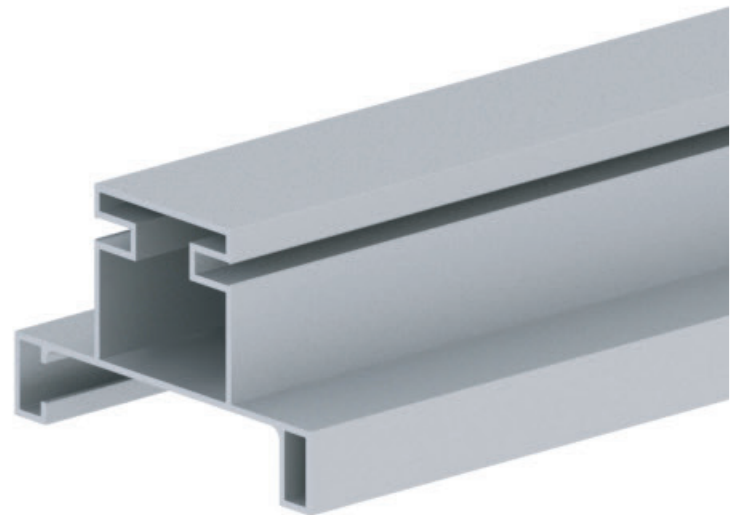
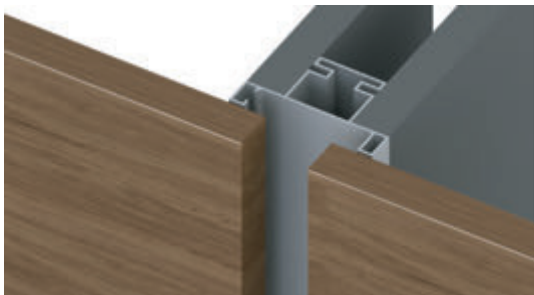

Incluye perfil PVC para instalación de LED 8mm.

Válido para casco de 16 y 19mm.



756 V2 LATERAL

| aluminio | Acabado finishes | Ref. model | mm. |  |
|---|------------------------------|-------------|-----------|---|
|  | Plata mate / anodized silver | 756.2400.31 | 2,4 mtrs. | 6 |
|  | Lacado blanco / white | 756.2400.06 | 2,4 mtrs. | 6 |



Incluye perfil PVC para instalación de LED 8mm.

Válido para casco de 16 y 19mm.





**EL CONTACTO CON LO NATURAL ES EL
ORIGEN DEL BIENESTAR.**

Los objetos que nos acompañan durante nuestra vida, crean momentos especiales en la memoria.

El valor de la tradición y la experiencia nos permite crear una colección con una diversidad de texturas y formas que aportan a cada tirador una esencia singular.

CLASSICS

**THE CONTACT WITH NATURE IS THE
SOURCE OF WELFARE.**



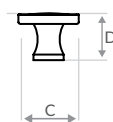
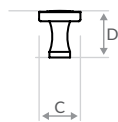
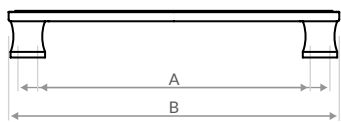

The things that stay with us throughout our lives, create special moments in our memory.

The importance we give to tradition and the experience, allows us to create a collection with a variety of textures and forms that provide, for each handle, a unique essence.



348

349

| zamak | Acabado finishes | Ref. model | A | B | C | D |  |  |
|---|--------------------------------------|------------|---------|-----|----|----|---|---|
|  | Provenzal <i>brush brass</i> | 348.128.03 | 128*160 | 170 | 24 | 26 | 20 | 60 |
| | | 349.036.03 | 16 | 35 | - | 28 | 25 | 75 |
| | | 349.055.03 | 16 | 55 | - | 30 | 25 | 75 |
|  | Plata Vieja <i>antique silver</i> | 348.128.05 | 128*160 | 170 | 24 | 26 | 20 | 60 |
| | | 349.036.05 | 16 | 35 | - | 28 | 25 | 75 |
| | | 349.055.05 | 16 | 55 | - | 30 | 25 | 75 |

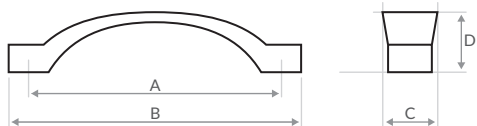

347

zamak

Acabado finishes

Ref. model

A

B

C

D



Provenzal
brush brass

347.096.03

96

117

23

24

25

75



Plata Vieja
antique silver

347.096.05

96

117

23

24

25



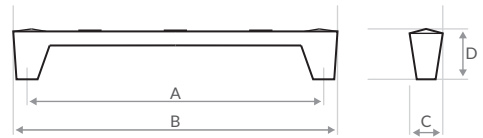
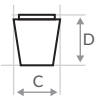

75





346





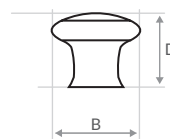
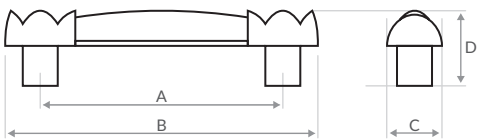

345

| zamak | Acabado finishes | Ref. model | A | B | C | D |  |  |
|--|--------------------------------------|--------------------------|-----|-----------|----------|----|---|---|
|  | Provenzal <i>brush brass</i> | 345.160.03 346.022.03 | 160 | 179 22 | 29 25 | 27 | 25 | 75 |
|  | Plata Vieja <i>antique silver</i> | 345.160.05 346.022.05 | 160 | 179 22 | 29 25 | 27 | 25 | 75 |





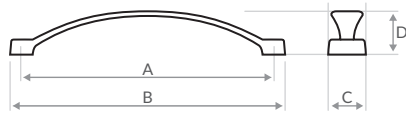

554

555

| zamak/porcelana | Acabado finishes | Ref. model | A | B | C | D |  |  |
|---|--|------------|----|-----|----|----|---|---|
|  | Latón Rústico / Porcelana <i>antique brass / porcelain</i> | 554.096.33 | 96 | 126 | 22 | 30 | 20 | 60 |
|  | Plata Rústica / Porcelana <i>antique silver / porcelain</i> | 554.096.55 | 96 | 126 | 22 | 30 | 20 | 60 |
|  | Latón Rústico / Porcelana <i>antique brass / porcelain</i> | 555.036.33 | - | 34 | - | 29 | 20 | 60 |
|  | Plata Rústica / Porcelana <i>antique silver / porcelain</i> | 555.036.55 | - | 34 | - | 29 | 20 | 60 |







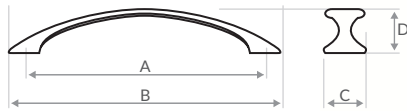

296

| zamac | Acabado finishes | Ref. model | A | B | C | D |  |  |
|---|--------------------------------------|------------|-----|-----|----|----|---|---|
|  | Provenzal <i>brush brass</i> | 296.UVA.03 | 128 | 136 | 20 | 25 | 50 | 150 |
| | | 296.FRU.03 | 128 | 136 | 20 | 25 | 50 | 150 |
|  | Plata Vieja <i>antique silver</i> | 296.UVA.05 | 128 | 136 | 20 | 25 | 50 | 150 |
| | | 296.FRU.05 | 128 | 136 | 20 | 25 | 50 | 150 |





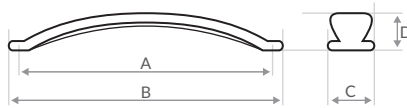

293

| zamac | Acabado finishes | Ref. model | A | B | C | D |  |  |
|---|---------------------------------------|------------|-----|-----|----|----|---|---|
|  | Provenzal <i>brush brass</i> | 293.TRI.03 | 128 | 155 | 19 | 25 | 50 | 150 |
|  | Plata Vieja <i>antique silver</i> | 293.TRI.05 | 128 | 155 | 19 | 25 | 50 | 150 |
|  | Latón Rústico <i>antique brass</i> | 293.TRI.33 | 128 | 155 | 19 | 25 | 50 | 150 |
|  | Cobre Viejo <i>antique copper</i> | 293.TRI.99 | 128 | 155 | 19 | 25 | 50 | 150 |





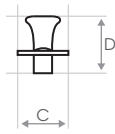
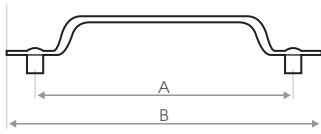

283

| zamac | Acabado finishes | Ref. model | A | B | C | D |  |  |
|---|--------------------------------------|------------|-----|-----|----|----|---|---|
|  | Provenzal <i>brush brass</i> | 283.128.03 | 128 | 136 | 20 | 25 | 50 | 150 |
|  | Plata Vieja <i>antique silver</i> | 283.128.05 | 128 | 136 | 20 | 25 | 50 | 150 |
|  | Cobre Viejo <i>antique copper</i> | 283.128.99 | 128 | 136 | 20 | 25 | 50 | 150 |







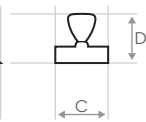
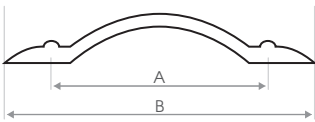

342

| zamak | Acabado finishes | Ref. model | A | B | C | D |  |  |
|---|--|------------|-----|-----|----|----|---|---|
|  | Latón Rústico <i>antique brass</i> | 342.128.33 | 128 | 155 | 16 | 36 | 40 | 120 |
|  | Plata Rústica <i>antique silver</i> | 342.128.55 | 128 | 155 | 16 | 36 | 40 | 120 |







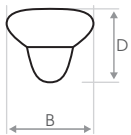

334

| zamak | Acabado finishes | Ref. model | A | B | C | D |  |  |
|---|--|------------|-----|-----|----|----|---|---|
|  | Latón Rústico <i>antique brass</i> | 334.128.33 | 128 | 170 | 29 | 27 | 30 | 90 |
|  | Pavonado <i>blued</i> | 334.128.51 | 128 | 170 | 29 | 27 | 30 | 90 |
|  | Plata Rústica <i>antique silver</i> | 334.128.55 | 128 | 170 | 29 | 27 | 30 | 90 |
|  | Cobre Rústico <i>rustic copper</i> | 334.128.98 | 128 | 170 | 29 | 27 | 30 | 90 |





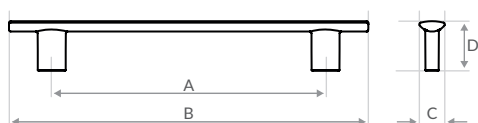

335

| zamak | Acabado finishes | Ref. model | A | B | C | D |  |  |
|---|--|------------|---|----|---|----|---|---|
|  | Latón Rústico <i>antique brass</i> | 335.032.33 | - | 32 | - | 27 | 50 | 150 |
|  | Pavonado <i>blued</i> | 335.032.51 | - | 32 | - | 27 | 50 | 150 |
|  | Plata Rústica <i>antique silver</i> | 335.032.55 | - | 32 | - | 27 | 50 | 150 |
|  | Cobre Rústico <i>rustic copper</i> | 335.032.98 | - | 32 | - | 27 | 50 | 150 |







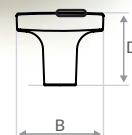
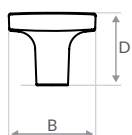

368 R

| zamak | Acabado finishes | Ref. model | A | B | C | D |  |  |
|---|--|------------|-----|-----|----|----|---|---|
|  | Latón Rústico <i>antique brass</i> | 368.096.33 | 96 | 146 | 15 | 21 | 50 | 150 |
| | | 368.160.33 | 160 | 210 | 15 | 29 | 30 | 90 |
|  | Plata Rústica <i>antique silver</i> | 368.096.55 | 96 | 146 | 15 | 21 | 50 | 150 |
| | | 368.160.55 | 160 | 210 | 15 | 29 | 30 | 90 |





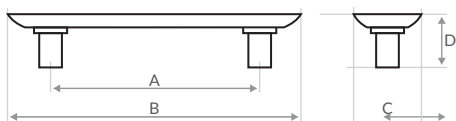

240R

241R

| zamak | Acabado finishes | Ref. model | A | B | C | D |  |  |
|---|--|------------|---|----|---|----|---|---|
|  | Latón Rústico <i>antique brass</i> | 240.024.33 | | 24 | | 20 | 100 | 300 |
| | | 240.032.33 | | 32 | | 26 | 50 | 150 |
|  | Plata Rústica <i>antique silver</i> | 240.024.55 | | 24 | | 20 | 100 | 300 |
| | | 240.032.55 | | 32 | | 26 | 50 | 150 |
|  | Latón Rústico <i>antique brass</i> | 241.024.33 | | 24 | | 20 | 100 | 300 |
| | | 241.032.33 | | 32 | | 26 | 50 | 150 |
|  | Plata Rústica <i>antique silver</i> | 241.024.55 | | 24 | | 20 | 100 | 300 |
| | | 241.032.55 | | 32 | | 26 | 50 | 150 |





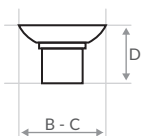

542

| zamak | Acabado finishes | Ref. model | A | B | C | D |  |  |
|--|--|------------|-----|-----|----|----|---|---|
|  | Latón Rústico <i>antique brass</i> | 542.096.33 | 96 | 125 | 19 | 23 | 25 | 75 |
| | | 542.128.33 | 128 | 157 | 19 | 23 | 25 | 75 |
|  | Plata Rústica <i>antique silver</i> | 542.128.55 | 128 | 157 | 19 | 23 | 25 | 75 |



543

| zamak | Acabado finishes | Ref. model | A | B | C | D |  |  |
|---|--|------------|---|----|----|----|---|---|
|  | Latón Rústico <i>antique brass</i> | 543.030.33 | | 30 | 32 | 20 | 25 | 75 |
| | | 543.030.55 | | 30 | 32 | 20 | 25 | 75 |
|  | Plata Rústica <i>antique silver</i> | | | | | | | |

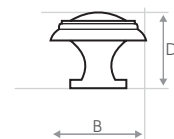
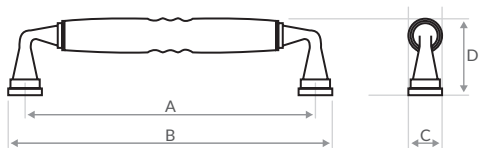

556

557

zamak/porcelana

Acabado finishes

Ref. model

A

B

C

D



Latón Rústico / Porc. Flor Azul
antique brass / porcelain blue flower

556.096.33A
556.128.33A
557.034.33A

96 112 18 34
128 142 19 34
- 34 - 29

25 75
25 75
25 75



Latón Rústico / Porc. Craquelé
antique brass / porcelain craquelé

556.096.33C
556.128.33C
557.034.33C

96 112 18 34
128 142 19 34
- 34 - 29

25 75
25 75
25 75



Latón Rústico / Porc. Flor Marrón
antique brass / porcelain brown flower

556.096.33M
556.128.33M
557.034.33M

96 112 18 34
128 142 19 34
- 34 - 29

25 75
25 75
25 75



Latón Rústico / Porc. Flor Verde
antique brass / porcelain green flower

556.096.33V
556.128.33V
557.034.33V

96 112 18 34
128 142 19 34
- 34 - 29

25 75
25 75
25 75



PATAS DE MUEBLES
ILUMINACIÓN LED
TIRADORES PARA VIDRIO

ACCESORIOS

FURNITURE LEG
LED LIGHTING
SHOWER SCREEN HANDLES





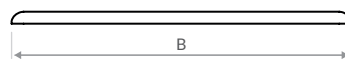

salva encimeras

worktop protect



822

821

| zamak | Acabado finishes | Ref. model | A | B | C | D |  |  |
|---|-------------------------------|------------|---|-----|----|---|---|---|
|  | Cromo Brillo bright chrome | 822.016.04 | - | - | 16 | 8 | 60 | 240 |
|  | Cromo Brillo bright chrome | 821.300.04 | - | 300 | 12 | 6 | 32 | 96 |

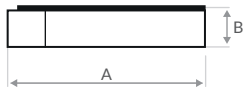
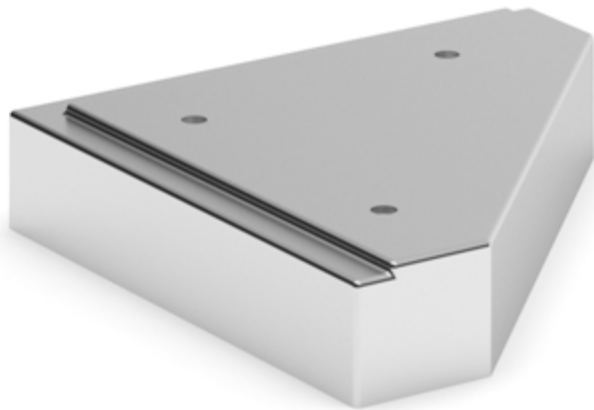

25

zamak

Acabado finishes

Ref. model

A

B

C

D



Cromo Brillo
bright chrome

25.120.04

120

25

-

-



24

72

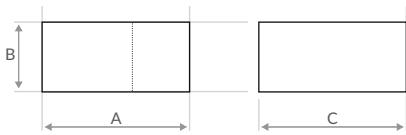
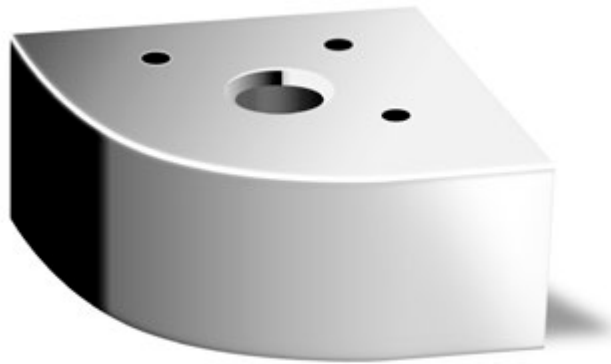





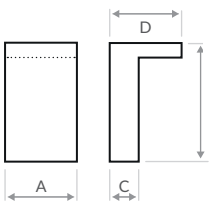

26

| zamak | Acabado finishes | Ref. model | A | B | C | D |  |  |
|---|--------------------------------------|------------|-----|----|-----|---|---|---|
|  | Cromo Brillo <i>bright chrome</i> | 26.045.04 | 100 | 45 | 100 | - | 6 | 24 |



22

| zamak | Acabado finishes | Ref. model | A | B | C | D |  |  |
|---|--|------------|----|-----|----|----|---|---|
|  | Cromo Brillo <i>bright chrome</i> | 22.070.04 | 90 | 70 | 15 | 55 | 25 | 75 |
| | | 22.100.04 | 50 | 100 | 15 | 55 | 25 | 100 |
| | | 22.150.04 | 50 | 150 | 20 | 55 | 25 | 75 |
|  | Cromo Mate <i>mat chrome</i> | 22.150.30 | 50 | 150 | 20 | 55 | 25 | 75 |
|  | Níquel Satinado <i>brushed satin nickel</i> | 22.150.58 | 50 | 150 | 20 | 55 | 25 | 75 |

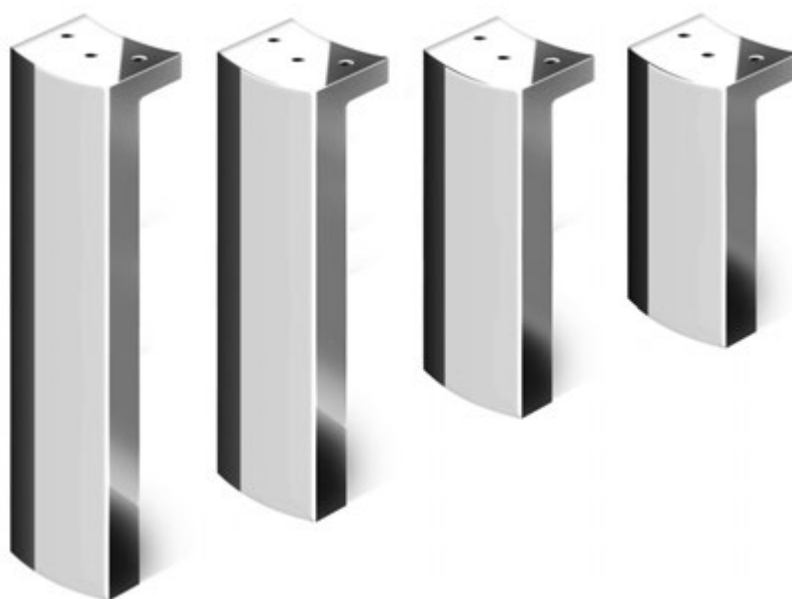
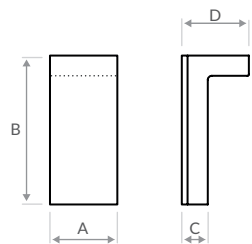

21

zamak

Acabado finishes

Ref. model

A

B

C

D



Cromo Brillo
bright chrome

21.100.04
21.150.04
21.200.04
21.260.04
21.300.04

50
50
50
50
50

100
150
200
260
300

17
17
17
17
19

40
50
50
50
50

25
25
2
12
8

100
75
50
36
24



Cromo Mate
mat chrome

21.150.30

50

150

17

50

25

75



Níquel Satinado
brushed satin nickel

21.150.58

50

150

17

50

25

75

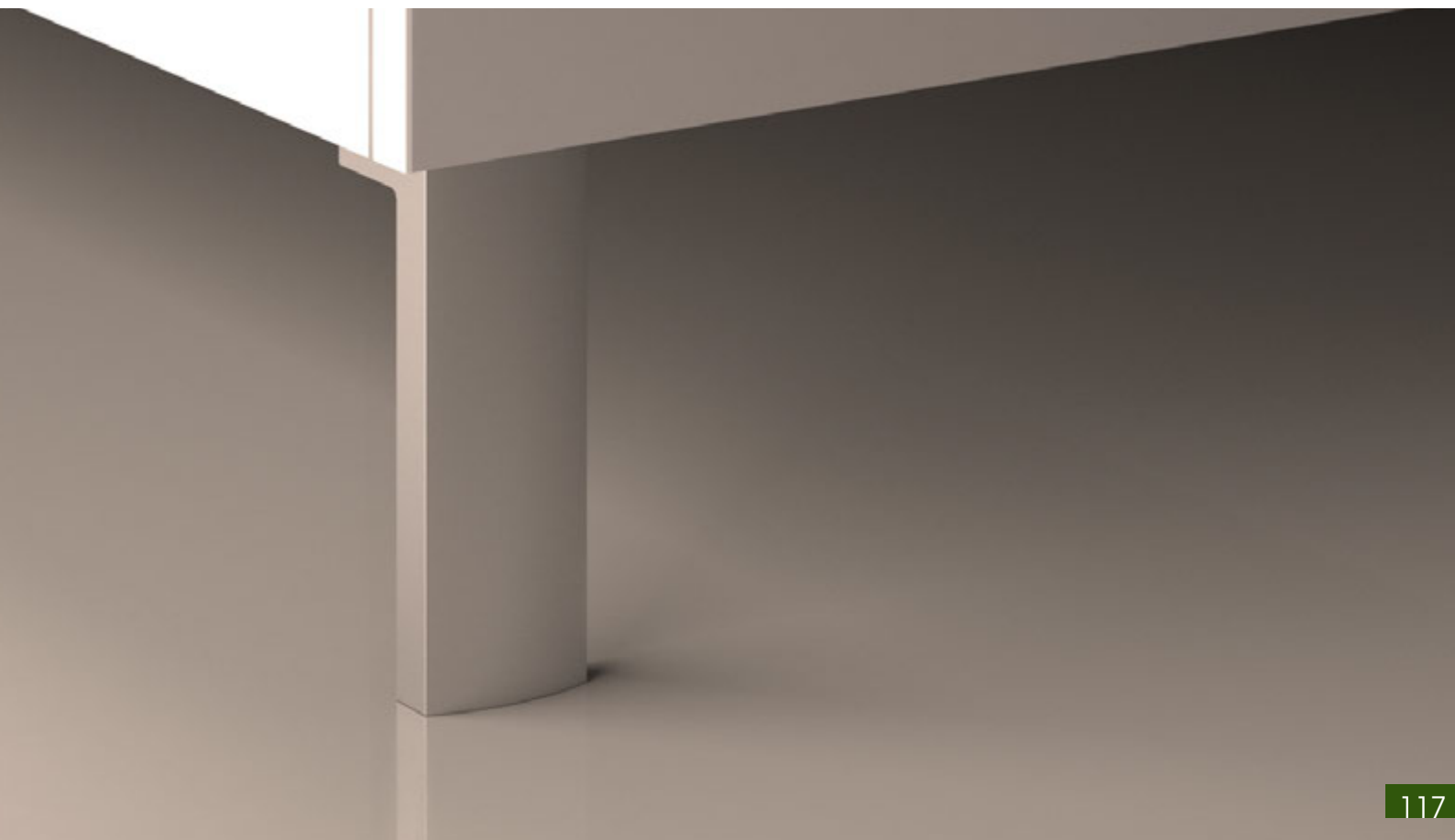

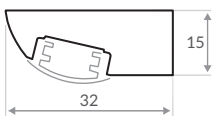

L105

| aluminio/zamak | Ref. model | largo length | W | LED | Lumen | °K | Color | Cable |  |
|----------------|------------|--------------|-----|------|-------|-----------|-----------------|---------------------------|---|
| | L105.350 | 35cm / 24LED | 4,8 | 2835 | 720 | 5500-6000 | Blanco white | 1,40m/macho 1,40m/male | 12 |
| | L105.550 | 55cm / 42LED | 11 | 2835 | 1260 | 5500-6000 | Blanco white | 1,40m/macho 1,40m/male | 12 |

con sensor doble función específico para puerta-cajón y on-off
with double function sensor for doors and on-off

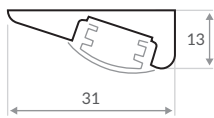

L106

| aluminio/zamak | Ref. model | largo length | W | LED | Lumen | °K | Color | Cable | |
|----------------|------------|--------------|-----|------|-------|-----------|-----------------|---------------------------|----|
| | L106.330 | 33cm / 24LED | 4,8 | 2835 | 720 | 5500-6000 | Blanco white | 1,40m/macho 1,40m/male | 12 |
| | L106.530 | 53cm / 42LED | 11 | 2835 | 1260 | 5500-6000 | Blanco white | 1,40m/macho 1,40m/male | 12 |

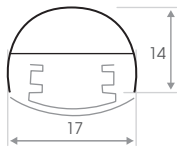

L107

| aluminio/zamak | Ref. model | largo length | W | LED | Lumen | °K | Color | Cable | |
|----------------|------------|--------------|-----|------|-------|-----------|-----------------|---------------------------|----|
| | L107.330 | 33cm / 24LED | 4,8 | 2835 | 720 | 5500-6000 | Blanco white | 1,40m/macho 1,40m/male | 12 |
| | L107.530 | 53cm / 42LED | 11 | 2835 | 1260 | 5500-6000 | Blanco white | 1,40m/macho 1,40m/male | 12 |

regleta LED orientable
adjustable LED profile

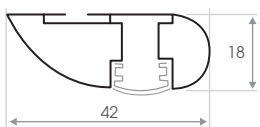

L108 neón

| aluminio/ABS | Ref. model | largo length | W | LED | Lumen | °K | Color | Cable |  |
|--------------|---|----------------|-----|------|-------|-----------|-----------------|---------------------------|---|
| | L108.520.ST | 52cm / 36LED | 8 | 7020 | 1350 | 5500-6000 | Blanco white | 1,40m/macho 1,40m/male | 12 |
| | L108.9200ST | 92cm / 63LED | 15 | 7020 | 2600 | 5500-6000 | Blanco white | 1,40m/macho 1,40m/male | 12 |
| | L108.1520ST | 152cm / 108LED | 23 | 7020 | 4050 | 5500-6000 | Blanco | 1,40m/macho 1,40m/male | 12 |
| | con sensor led touch azul función on-off with blue led touch sensor & on-off fuction | | | | | | | | |
| | L108.520.RGB | 52cm / 30LED | 7,2 | 5050 | 1350 | | RGB | 1,40m/macho | 12 |
| | L108.920.RGB | 92cm / 51LED | 13 | 5050 | 2600 | | RGB | 1,40m/macho | 12 |

con **mando a distancia** función on-off
with **retome control** & on-off fuction

L160.80

| aluminio | Ref. model | descripción description | V | W |
|----------|------------|--|----|---|
| | L160.80 | Foco LED SAMSUNG superficie <i>samsung led light surface</i> | 12 | 5 |
| | | 80x80x4 Blanco frío / aluminio <i>Cold white / aluminium</i> | | |



6



L160.60

| aluminio | Ref. model | descripción description | V | W |
|----------|------------|--|----|-----|
| | L160.60 | Foco LED SAMSUNG superficie <i>samsung led light surface</i> | 12 | 3,8 |
| | | 60x60x5 Blanco frío / aluminio <i>Cold white / aluminium</i> | | |



6



L160.65

| aluminio | Ref. model | descripción description | V | W |
|----------|------------|--|----|-----|
| | L160.65 | Foco LED SAMSUNG superficie <i>samsung led light surface</i> | 12 | 3,8 |
| | | 64x64x5 Blanco frío / aluminio <i>Cold white / aluminium</i> | | |



6



L160.62

| aluminio | Ref. model | descripción description | V | W |
|----------|------------|--|----|-----|
| | L160.62 | Foco LED superficie plástico <i>led light plastic surface</i> | 12 | 1,6 |
| | | 62x62 Blanco frío / aluminio <i>Cold white / aluminium</i> | | |



6



dimmer



6



| Ref. model | descripción description | V | W |
|------------|---|----|----|
| L141.72 | Regulador remoto <i>dimmer</i> función on/off. regulación de la intensidad. alcance remoto 30mtrs. | 12 | 72 |

*on/off. function.
dimmer.
remote control 30mtrs.*

sensor ir



6



| Ref. model | descripción description | V | W |
|------------|---|----|---|
| L140.72 | Sensor infrarrojo Incluye conectores europlug. Distancia encendido 5cm. | 12 | |

*europlug included.
5cm switching distance.*

transformador



6



| Ref. model | descripción description | V | W |
|------------|--|----|----|
| L131.09 | Transformador LED 3conexiones <i>led transformer 3 connections.</i> | 12 | 9 |
| L131.15 | Transformador LED 4conexiones <i>led transformer 3 connections.</i> | 12 | 15 |
| L131.20 | Transformador LED 4conexiones <i>led transformer 3 connections.</i> | 12 | 20 |

tiras led



6



| Ref. model | descripción description | rollo | color | V | W/M |
|-------------|-------------------------|--------|-------------|----|------|
| L110.500.98 | Tira LED RGB 10mm. | 5mtrs. | RGB | 12 | 14,4 |
| L120.200.06 | Tira LED 3014 8mm. | 2mtrs. | Blanco frío | 12 | 6,0 |
| L120.300.06 | Tira LED 3014 8mm. | 3mtrs. | Blanco frío | 12 | 6,0 |
| L120.500.06 | Tira LED 3014 8mm. | 5mtrs. | Blanco frío | 12 | 6,0 |
| L109.500.06 | Tira LED 5050 10mm. | 5mtrs. | Blanco frío | 12 | 14,4 |
| L122.500.06 | Tira LED 7020 12mm. | 5mtrs. | Blanco | 12 | 16,0 |



709

Juego de 2 Tiradores *set of 2 handles*
 VIDRIO: 6 - 8 - 10mm *glass: 6 - 8 - 10mm*

| REF. | MATERIAL | CC | TOTAL | ANCHO | ALTO |
|-----------|----------|-----|-------|-------|------|
| MT709.250 | Zamak | 250 | 320 | 25 | 28 |



770

Juego de 2 Tiradores *set of 2 handles*
 VIDRIO: 6 - 8 - 10mm *glass: 6 - 8 - 10mm*

| REF. | MATERIAL | CC | TOTAL | ANCHO | ALTO |
|------------|----------|----------|-------|-------|------|
| MT770.160 | Zamak | 160 | 185 | 25 | 28 |
| MT770.256 | Zamak | 256 | 281 | 25 | 28 |
| MT770.256a | Zamak | adhesivo | 281 | 25 | 28 |



801

Juego de 2 Tiradores *set of 2 handles*
 VIDRIO: 6 - 8 - 10mm *glass: 6 - 8 - 10mm*

| REF. | MATERIAL | CC | TOTAL | ANCHO | ALTO |
|-----------|----------|-----|-------|-------|------|
| MT801.192 | Zamak | 192 | 256 | 16 | 29 |



816

Juego de 2 Tiradores *set of 2 handles*
 VIDRIO: 6 - 8 - 10mm *glass: 6 - 8 - 10mm*

| REF. | MATERIAL | CC | TOTAL | ANCHO | ALTO |
|-----------|----------|-----|-------|-------|------|
| MT816.192 | Zamak | 192 | 214 | 10 | 26 |



771

Juego de 2 Pomos *set of 2 knobs*
 VIDRIO: 6 - 8 - 10mm *glass: 6 - 8 - 10mm*

| REF. | MATERIAL | CC | TOTAL | ANCHO | ALTO |
|----------|----------|----|-------|-------|------|
| MT771.40 | Zamak | - | 40 | - | 38 |



772

Juego de 2 Pomos *set of 2 knobs*
 VIDRIO: 6 - 8 - 10mm *glass: 6 - 8 - 10mm*

| REF. | MATERIAL | CC | TOTAL | ANCHO | ALTO |
|----------|----------|----|-------|-------|------|
| MT772.36 | Latón | - | 36 | - | 26 |

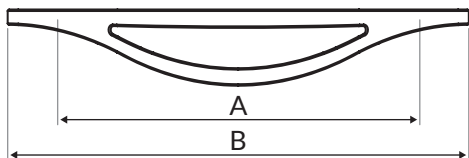

A distancia entre taladros
distance between drill holes

B largo total
total length

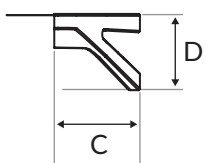

C ancho
width

D alto
height

834.160.04 número de modelo
model number

834.160.04 distancia entre taladros / largo total en modelos sin taladros
distance between drill holes / total length in models with no drill holes

834.160.04 referencia del acabado
reference of finishes



unidades por caja
units for each box



unidades por embalaje de cajas
units for pack of boxes

NOTAS

1994-2014

ANIVERSARIO



Avenida de las Naciones, 31
45200 ILLESCAS, Toledo SPAIN
Tel. +34 925 51 24 24
Fax. +34 925 54 08 74
info@sc-herrajes.com

www.sc-herrajes.com



AENOR
R
Empresa
Registrada
EN 0369/2004

